

TROUBLESHOOTING GUIDE

(for all Gen II units)

This guide contains information for identifying and correcting any issues that may arise.



Product Support/Warranty

If the water heater requires additional service, please use one of the following options for contacting Intellihot Technical Support:

- Call: 309-473-8040 (toll-free 1-877-835-1705), press 1
- Email: support@intellihot.com

When contacting Technical Support, please have the following information ready:

- Model Number
- Serial Number
- Date Purchased/Installed
- Installation location & application

Table of Contents

Air Filter Blocked Alert	3
Air Filter Service Alert	4
Air Filter Switch Wiring Alert	5
Blocked Flue Fault	6
Blower Speed Fault/Blower Fault.....	7
Blower Speed Signal Fault	8
Breaker Tripped (Over-Load)	9
Cascading Alert (Fault).....	10
Dead Unit – No Power Up	11
Flow Sensor Fault	12
Flue Overheat Fault	13
Fuel Type Alert	14
Heat Exchanger Overheat	15
Ignition Fault	16
Manifold Inlet/Outlet Wiring Alert	17
Pump Fault	18
Rough Ignition	19
Rumbling	20
Sensor Fault (Fault/Open/Shorted)	21
Water Valve Opening/Closing/Switch Fault	22
Water Valve Fault	23

Appendix

Blower Replacement	24
Gas Valve Replacement	24
Electrode Replacement	27
Controller Pin Layout	28
Wiring Diagram (Wall-Hung)	28
Wiring Diagram (Floor-Standing)	29
Gas Valve Detail	30
Resettable Overheat Switch	32

Suggested Tool List

- Digital Manometer
- Electrical Multimeter
- Flue Gas Analyzer (for NO_x & CO₂)
- 7mm Socket/Ratchet
- #1 & #2 Phillips Screwdrivers
- Instrument Flat Blade Screwdriver
- Pliers
- Adjustable Wrench

Air Filter Blocked Alert

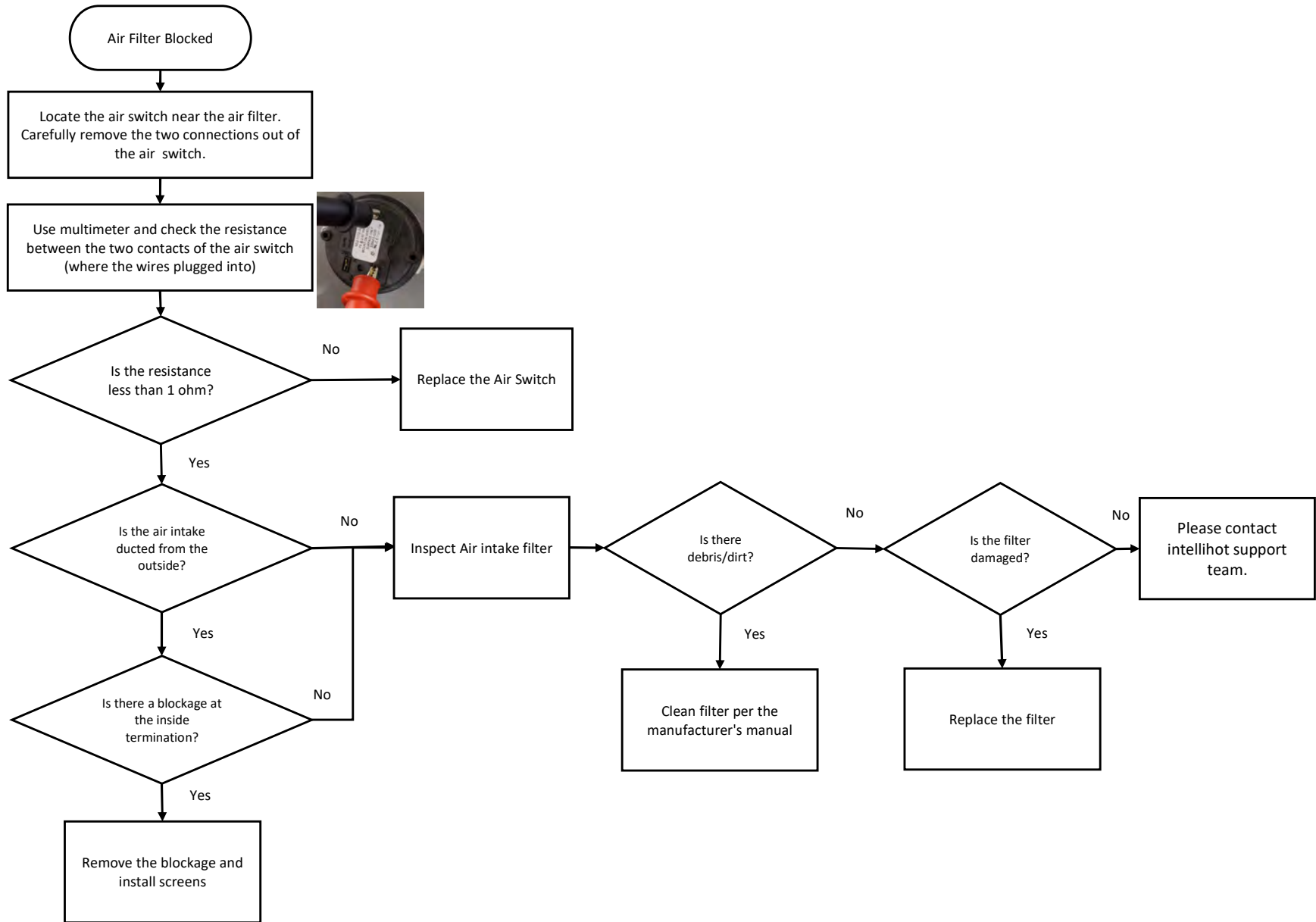

Air Filter Service Alert Maintenance Alert

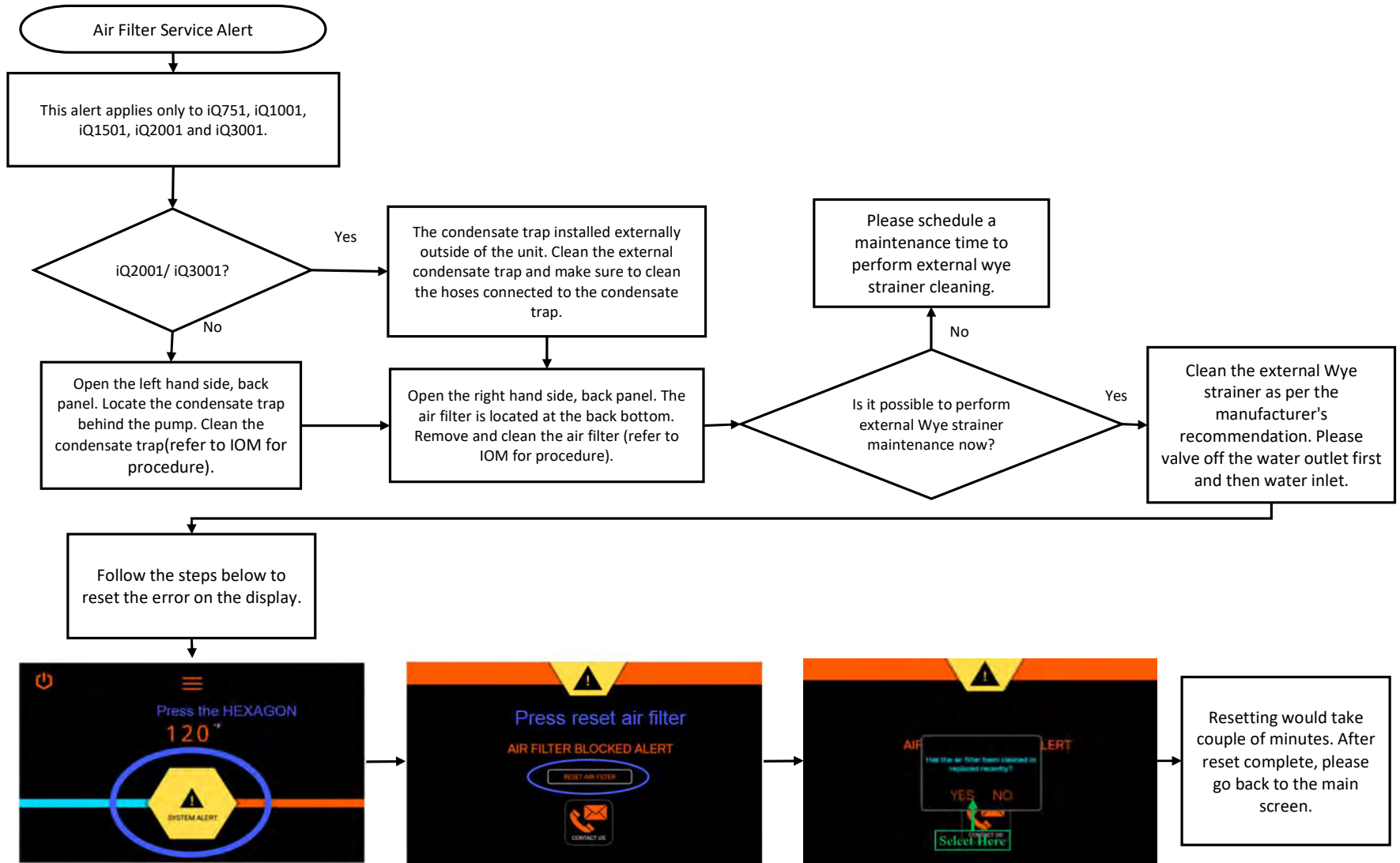

Air Filter Switch Wiring Alert

Air Filter Switch Wiring Alert

This alert applies only to iQ751, iQ1001, iQ1501, iQ2001 and iQ3001. The air filter switch wires are in yellow & black colors, and connected J10 on the control board.

iQ3001?

Yes

Check air filter wiring at HEX9 & HEX12's control board.

No

iQ2001?

Yes

Check air filter wiring at HEX6 & HEX8's control board.

No

For all other models, check the air filter wiring at each Heat exchanger's control board

Wires came loose or not connected?

No

Yes

Fix the connection

Broken or damaged wiring?

No

Yes

Replace the air filter wiring harness

Please contact intellihot support

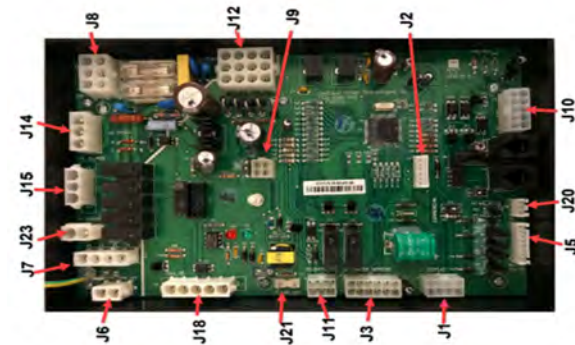

Blocked Flue Fault

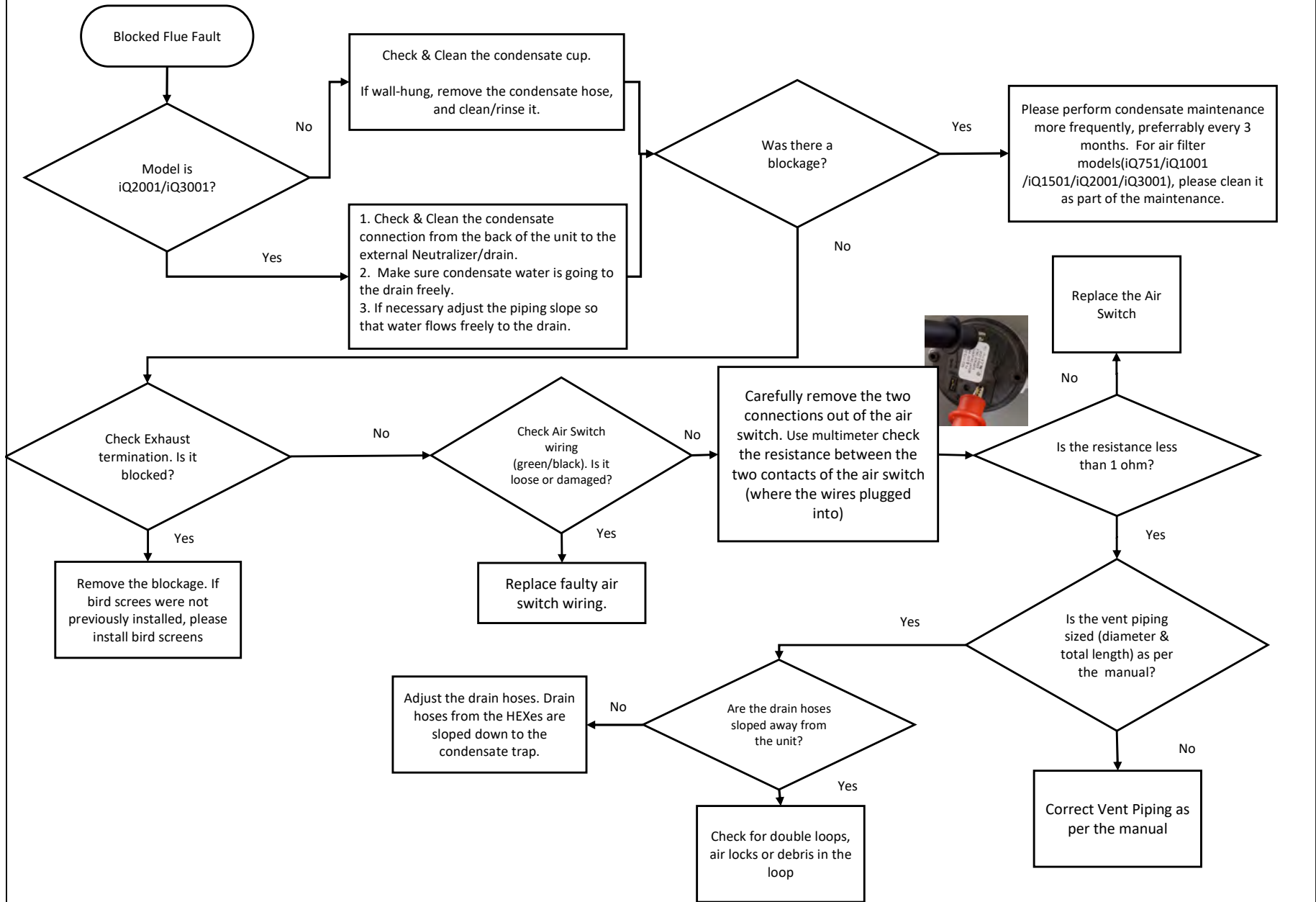

Blower Fault / Blower Speed Fault

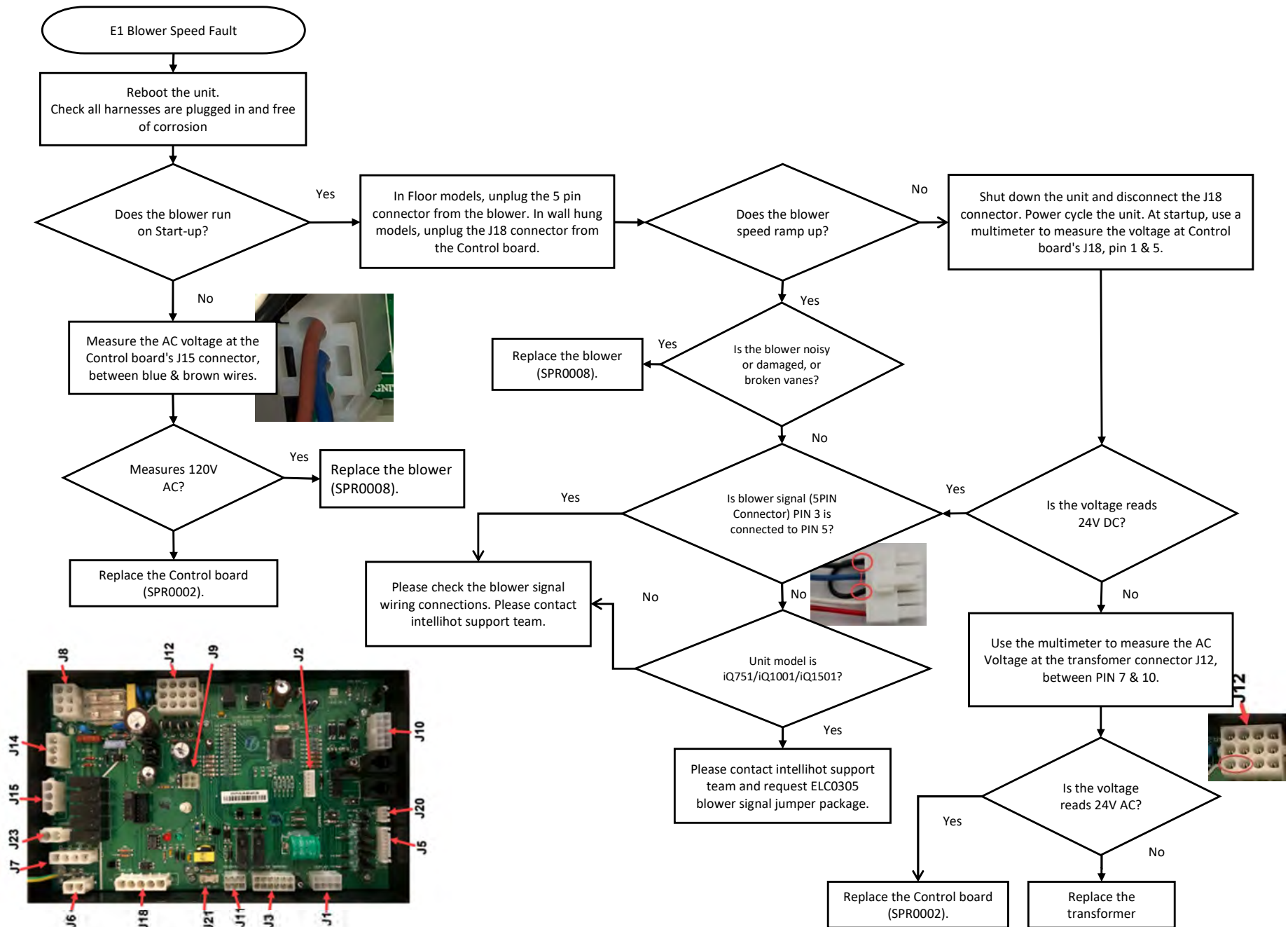

Blower Speed Signal Fault

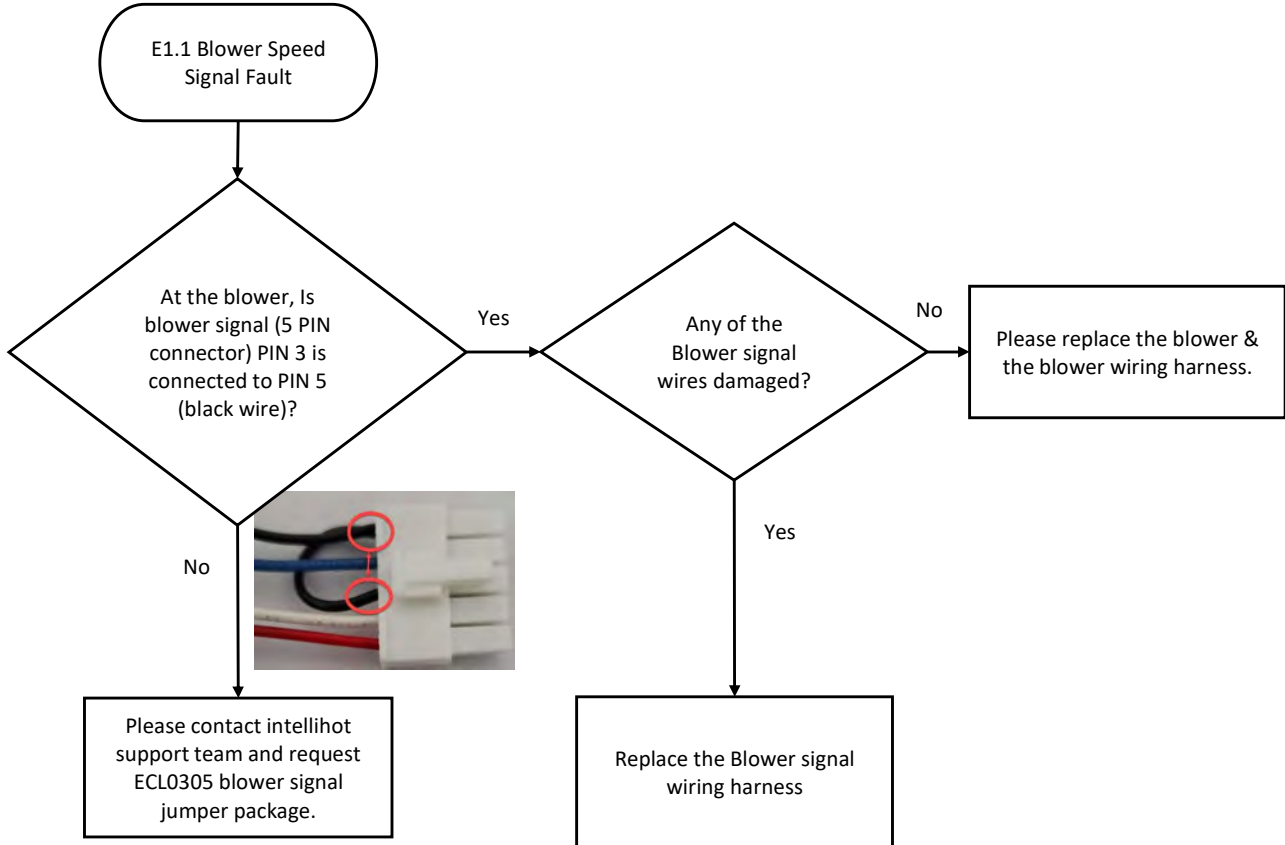

Breaker Tripped

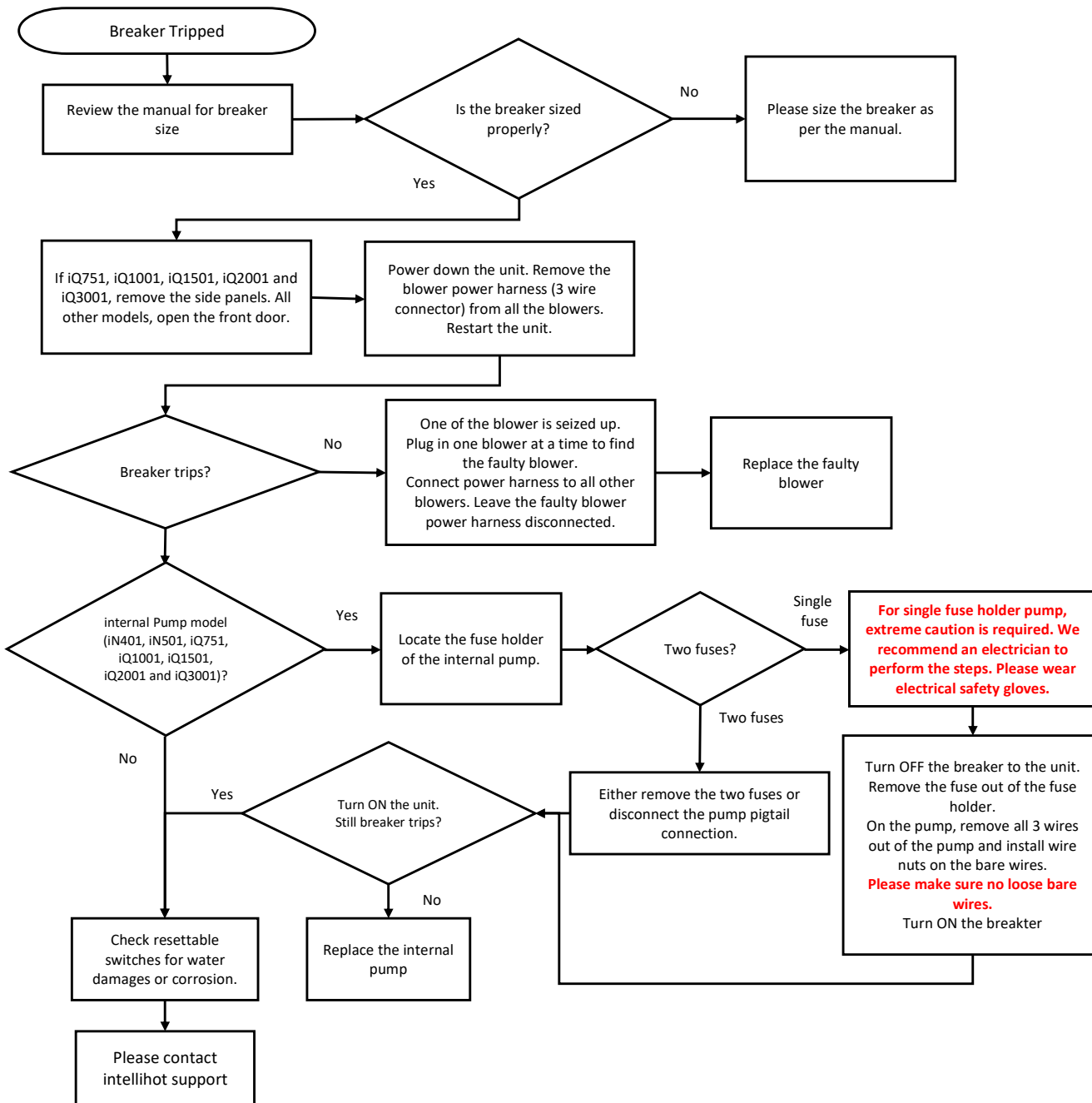

Cascading Alert (Fault)

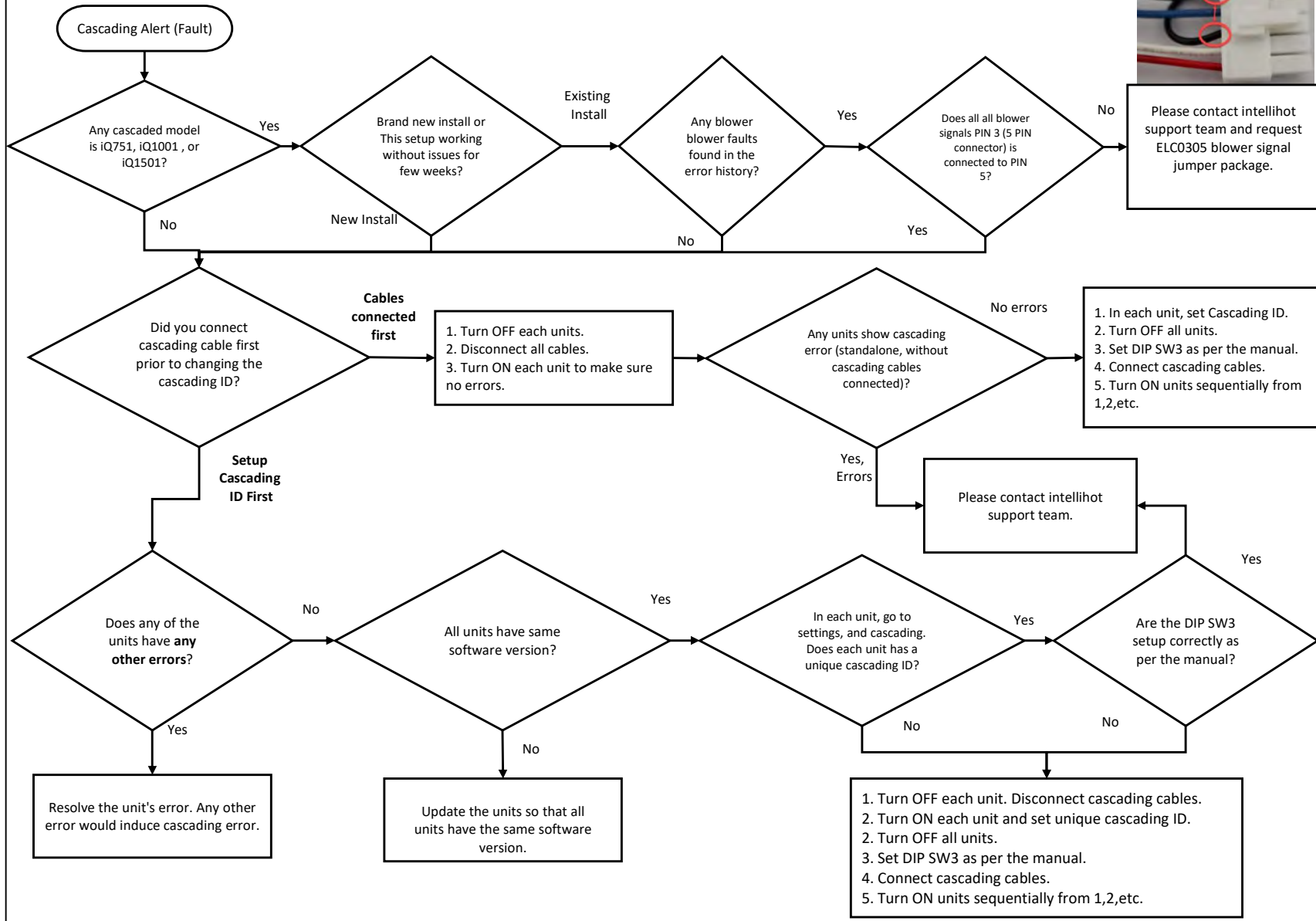
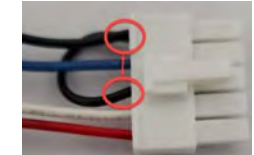

Dead Unit - No Power Up

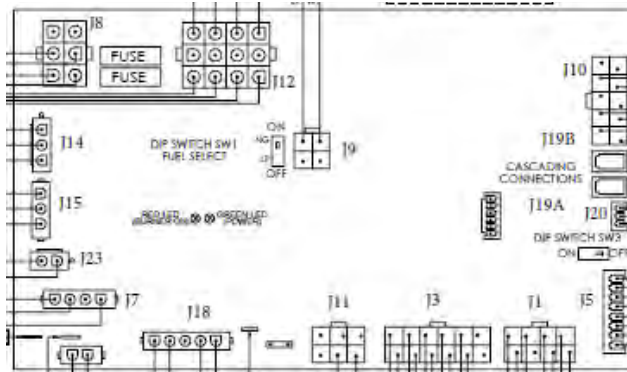
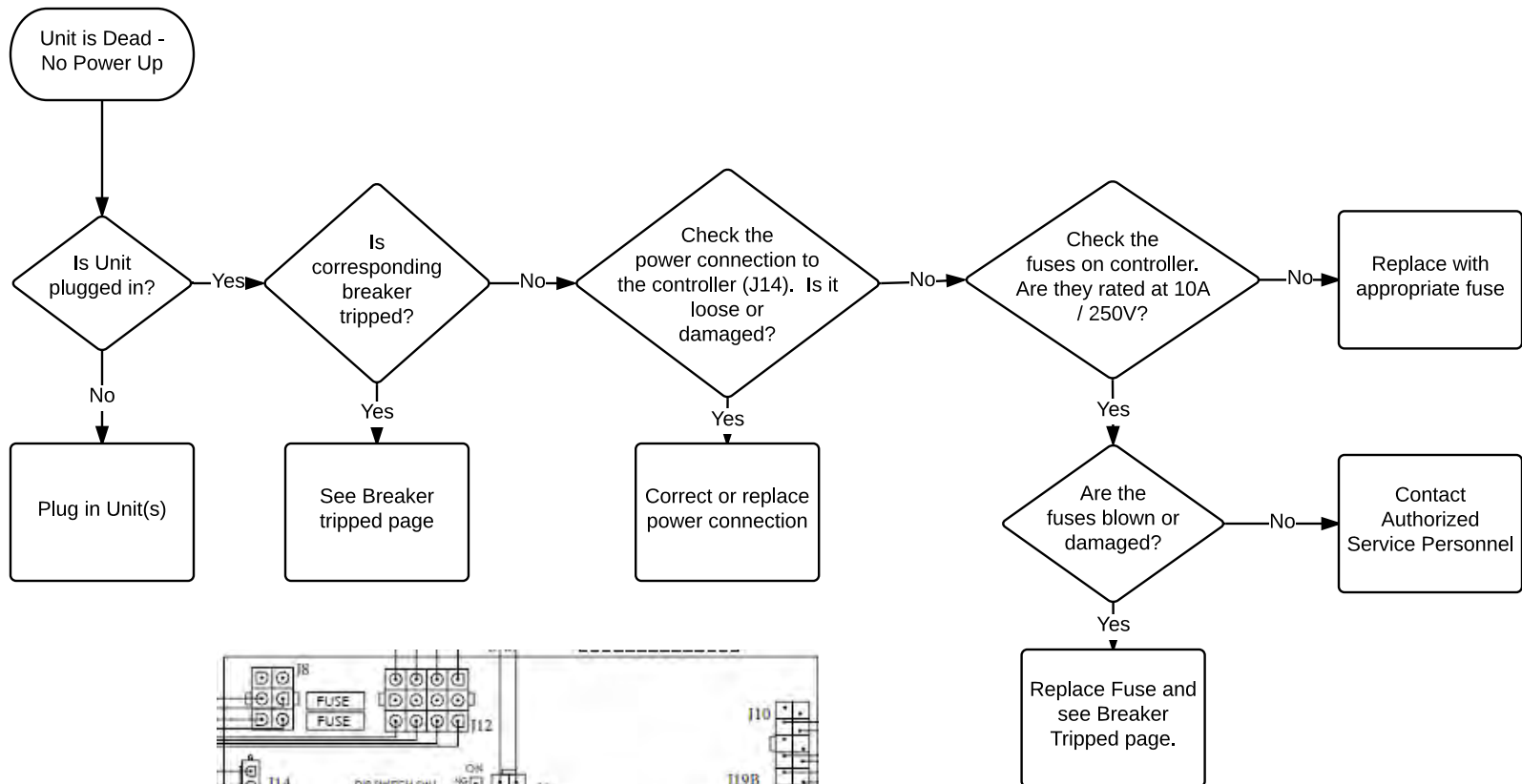

Flow Sensor Fault

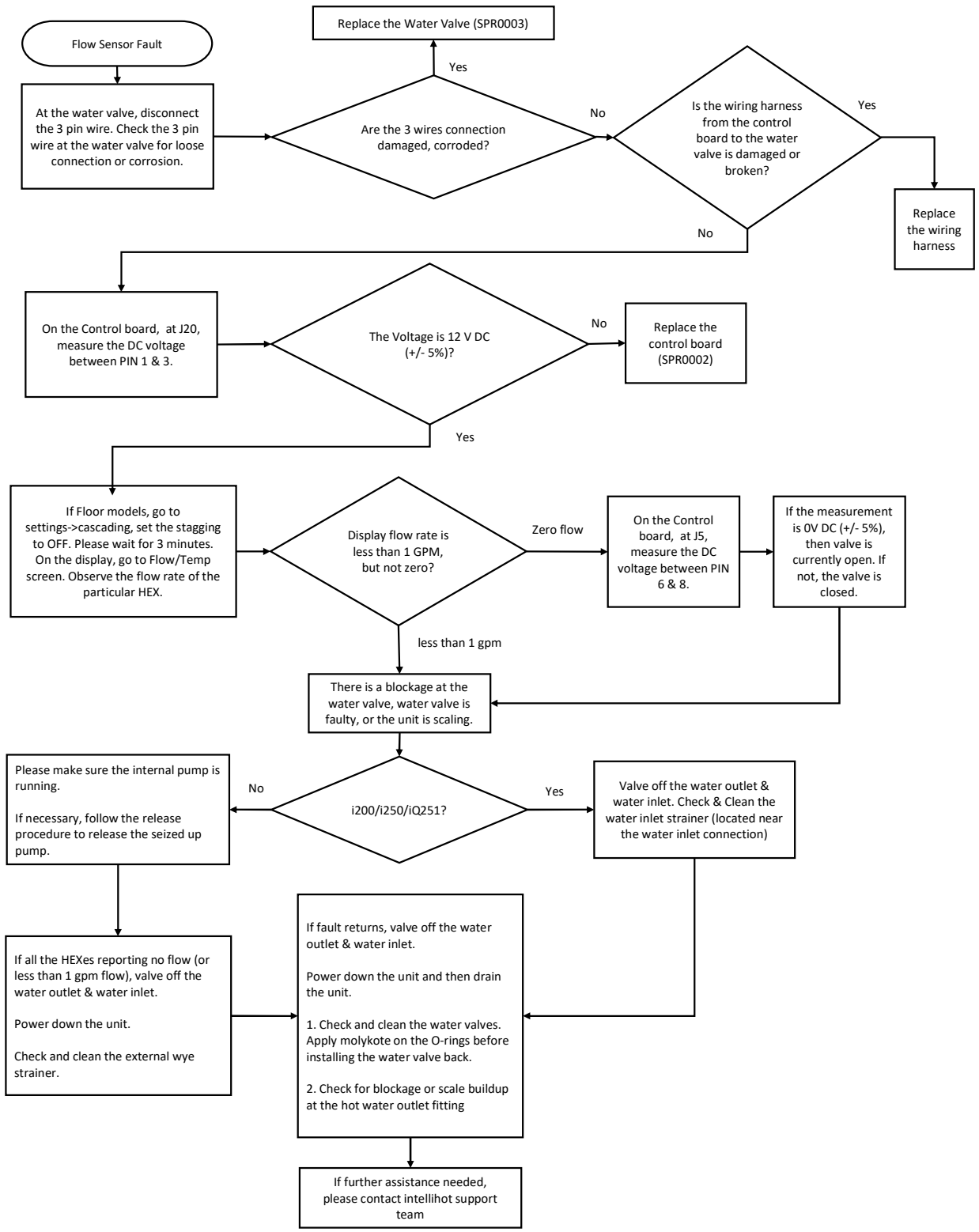

Flue Overheat Fault

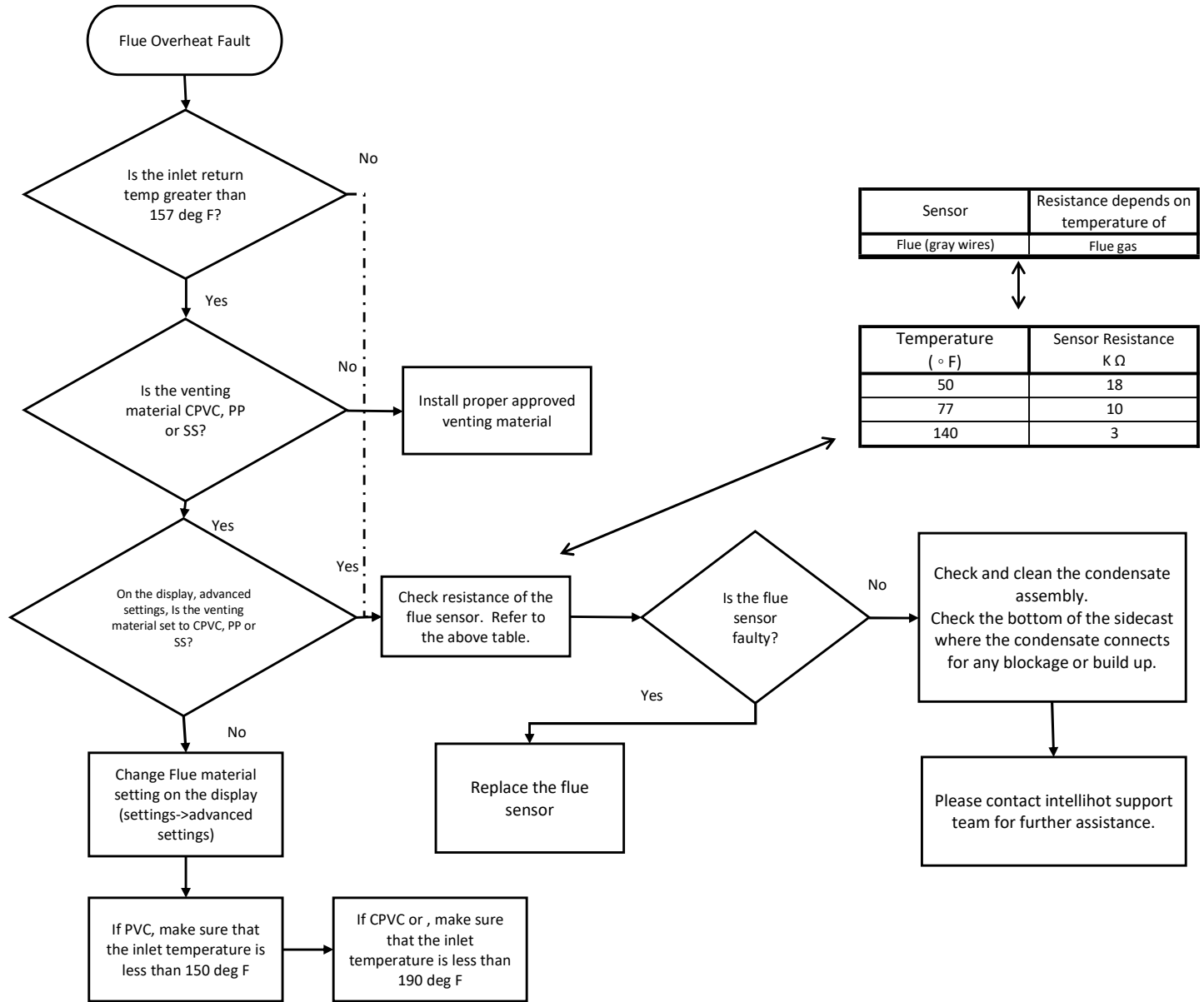

Fuel Type Alert Fuel Type Mismatch

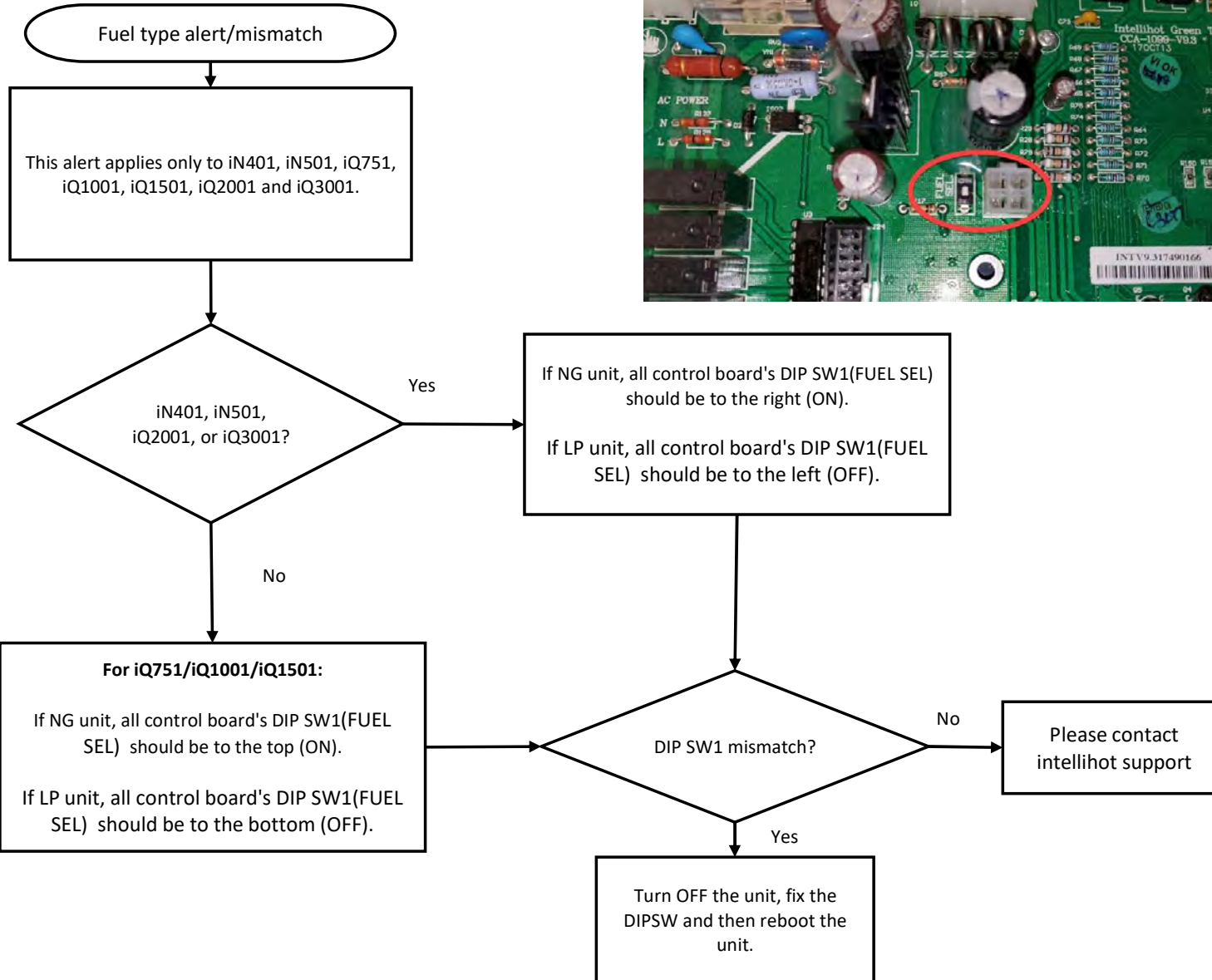

Heat Exchanger Overheat

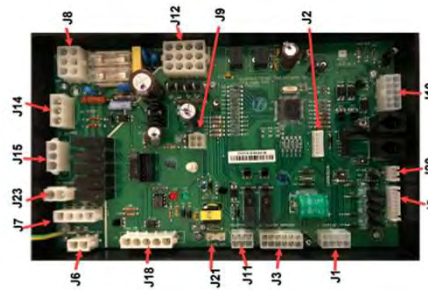
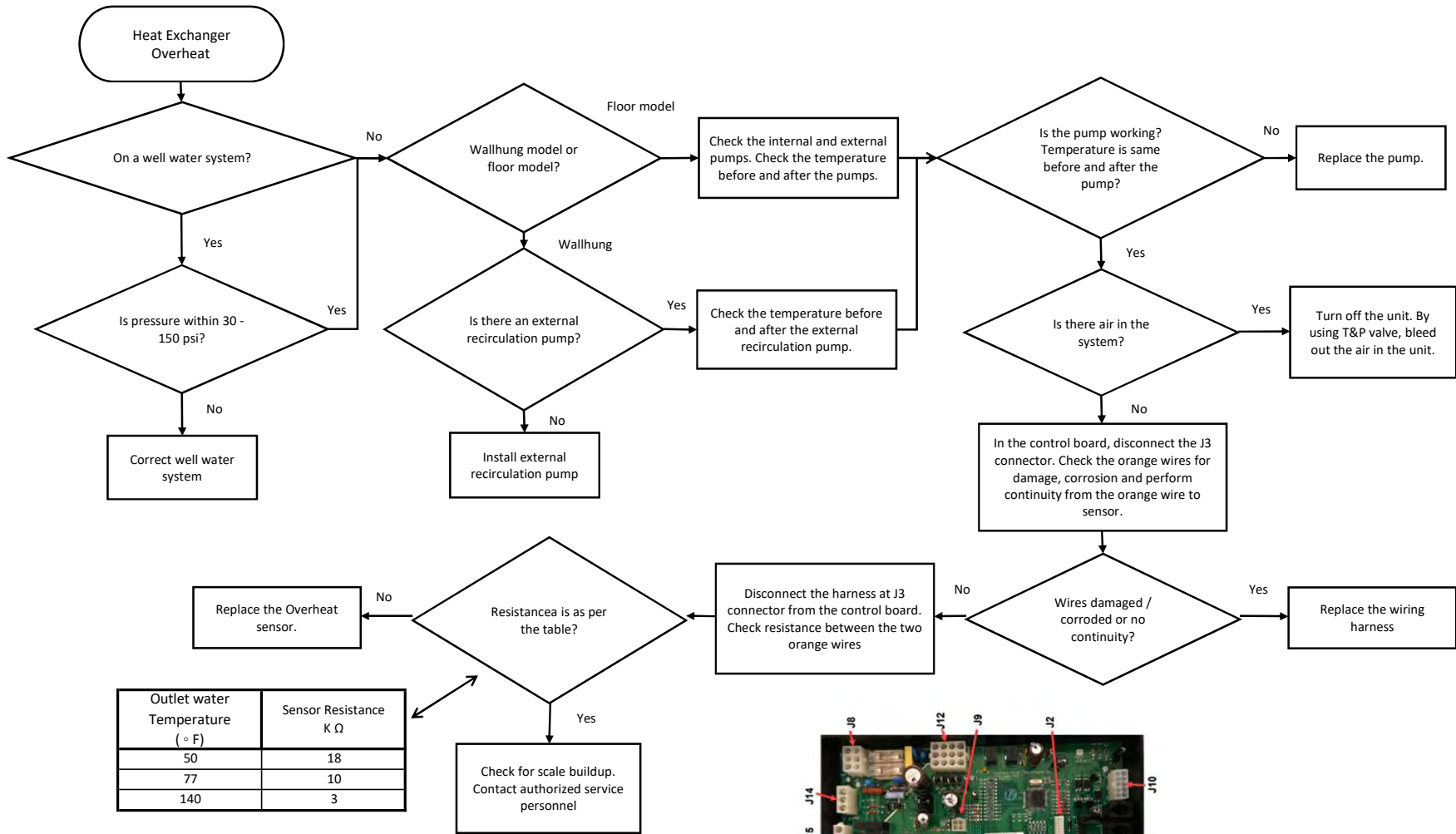

Ignition Fault

Page 1 of 3 Ignition Fault

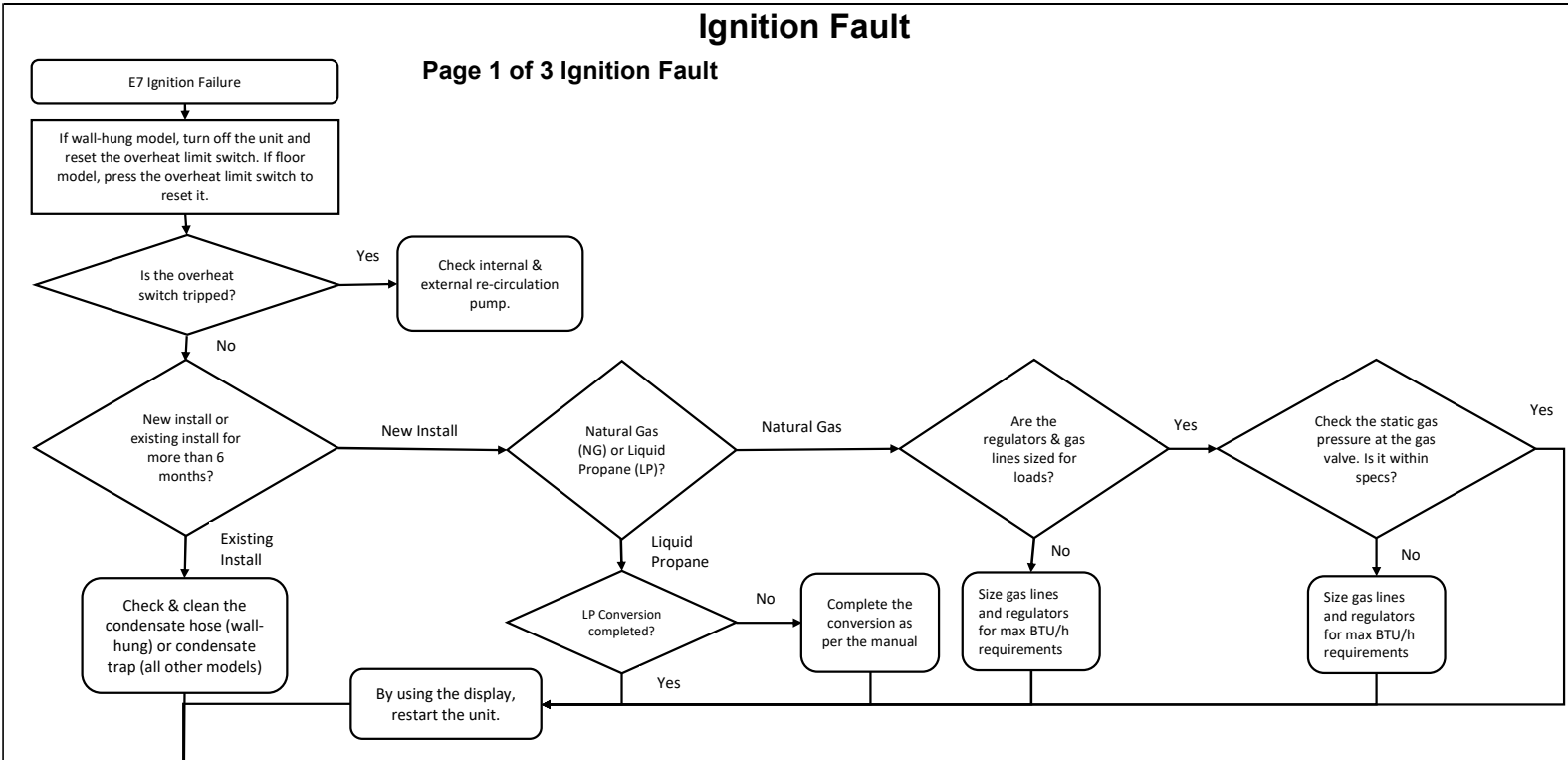

Page 2 of 3 Ignition Fault

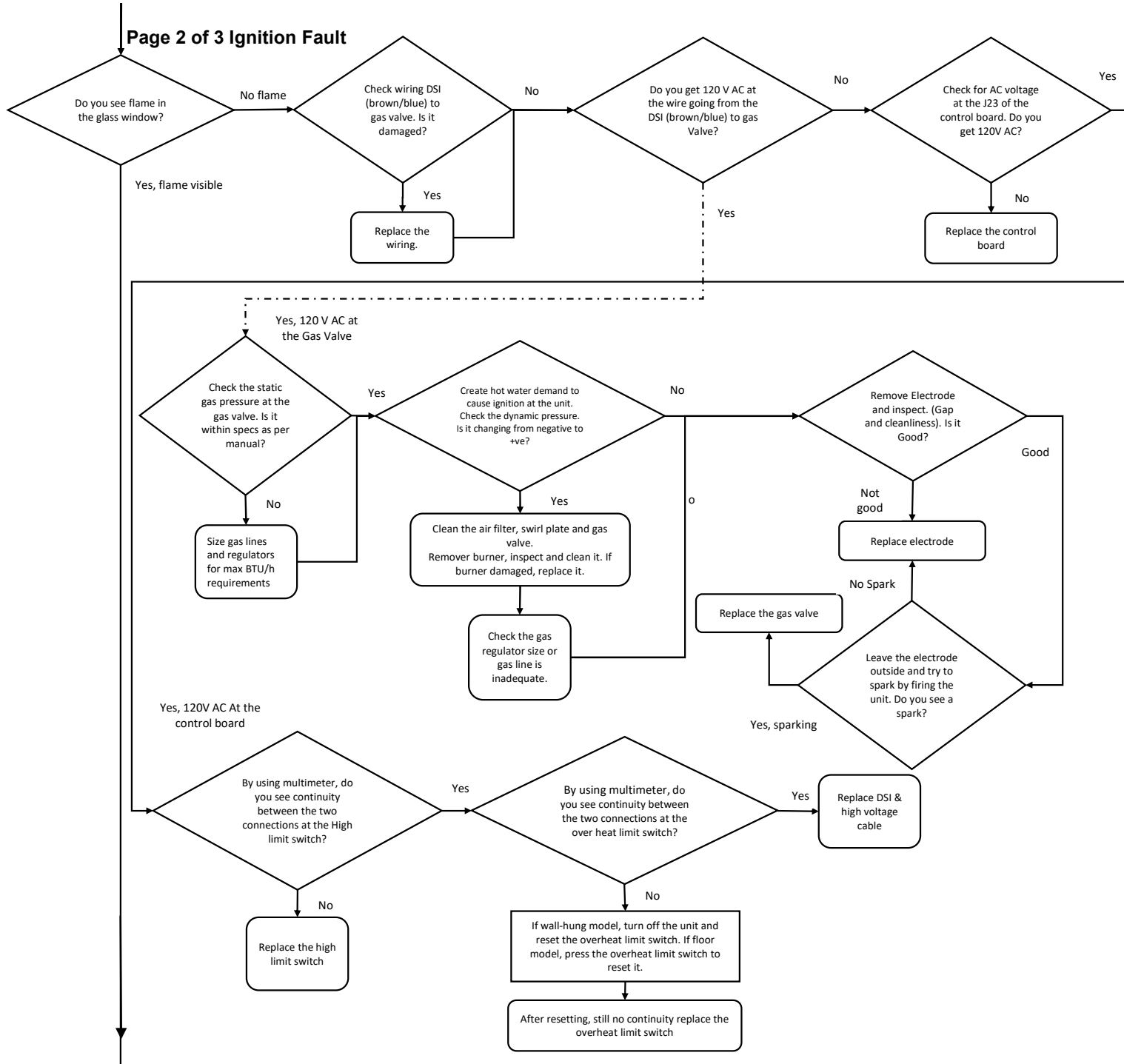

Page 3 of 3 Ignition Fault

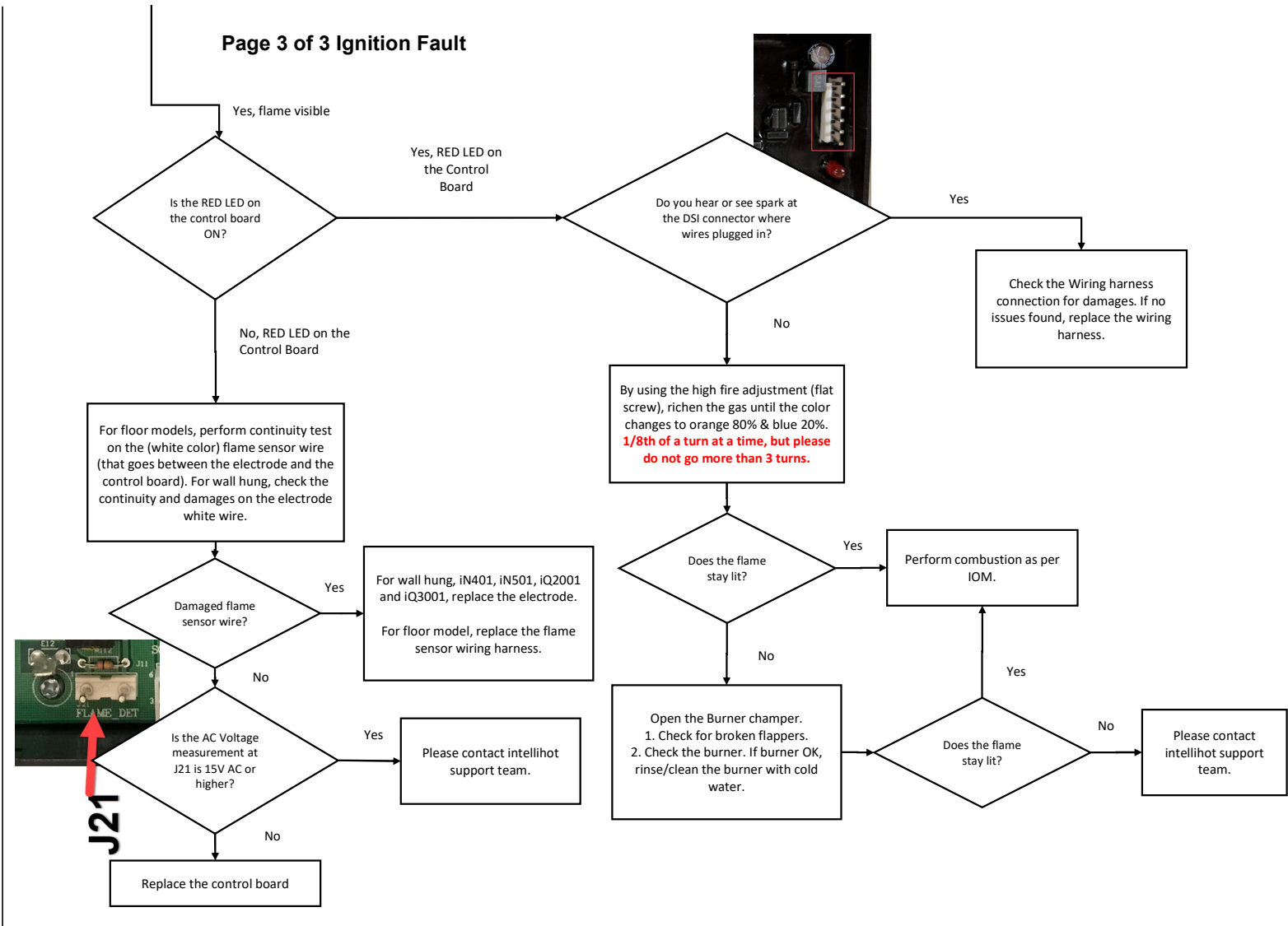

Manifold Inlet/Outlet Wiring Alert

Wiring Alert

This alert applies only to iN401, iN501, iQ751, iQ1001, iQ1501, iQ2001 and iQ3001. Refer to the table for the wiring color. The manifold sensor wires are connected to J3 on the control board.

Sensor	Resistance depends on temperature of
Manifold Inlet (Black & White)	Unit's cold water Inlet
Manifold Outlet (Orange & Black)	Unit's hot water outlet

Wire color table:
Manifold Inlet - Manifold Inlet sensor (Black & White)
Manifold Outlet - Manifold Outlet sensor (Orange & Black)
 The manifold wires are connected J3 on the control board.

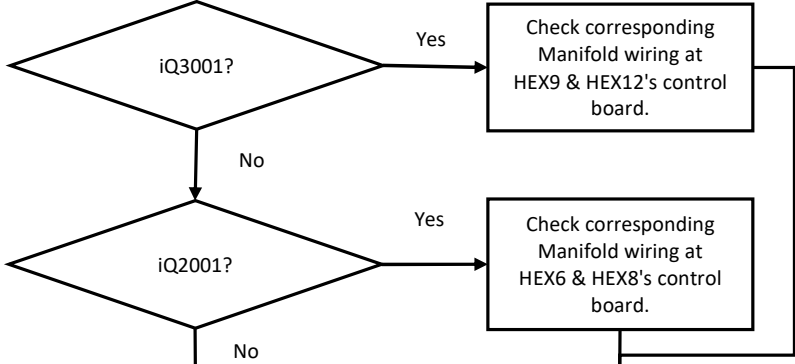

For all other models, check the corresponding Manifold wiring at each Heat exchanger's control board.

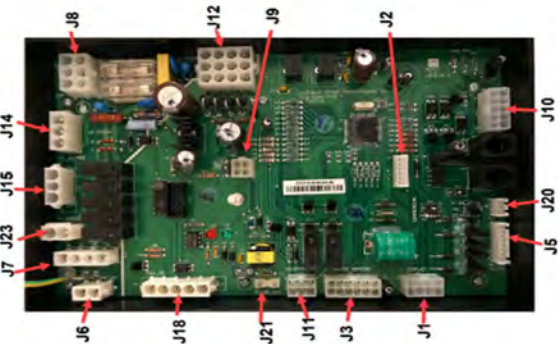
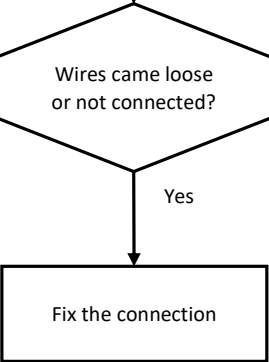

Pump Alert

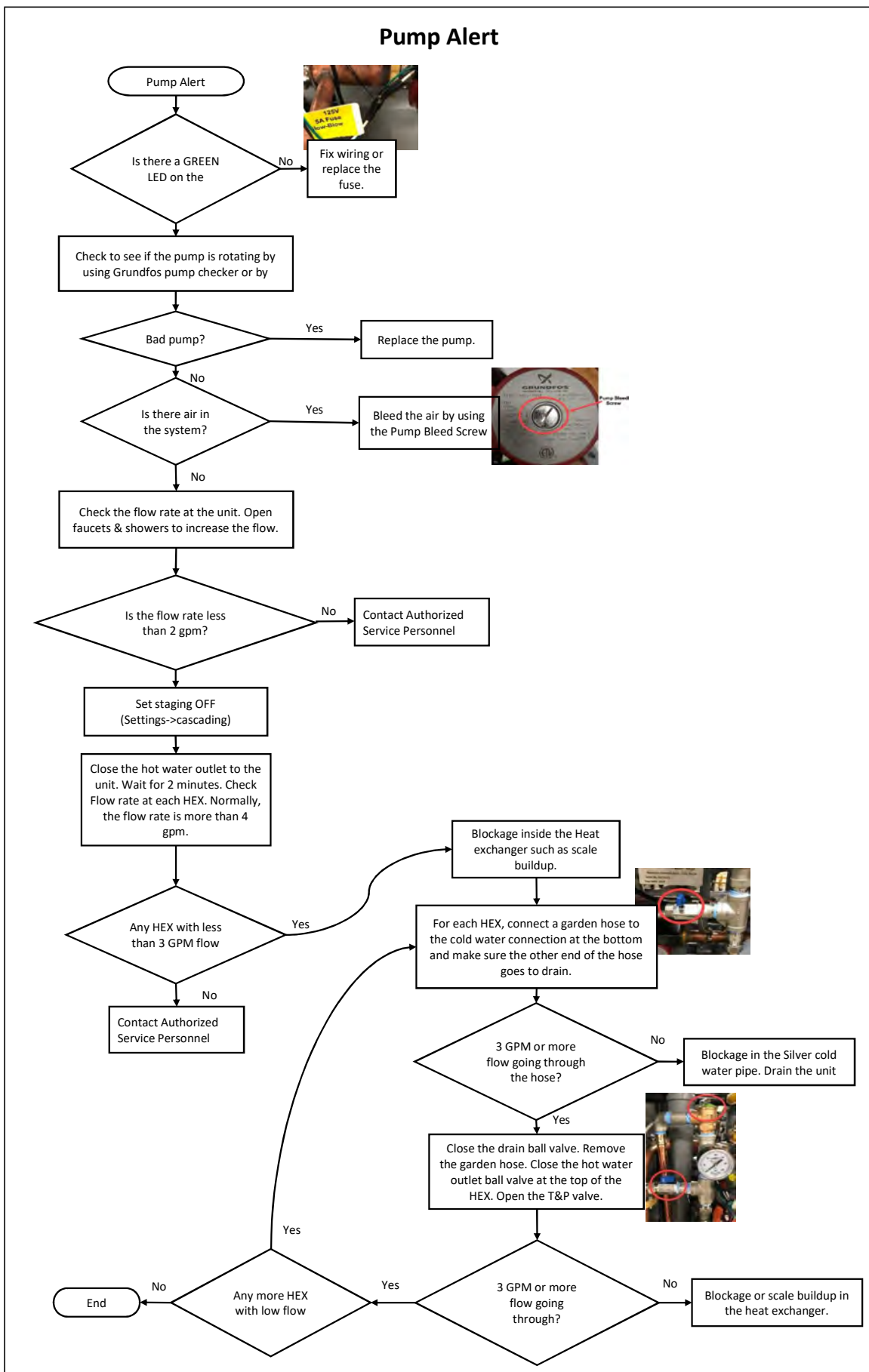

Rough Ignition

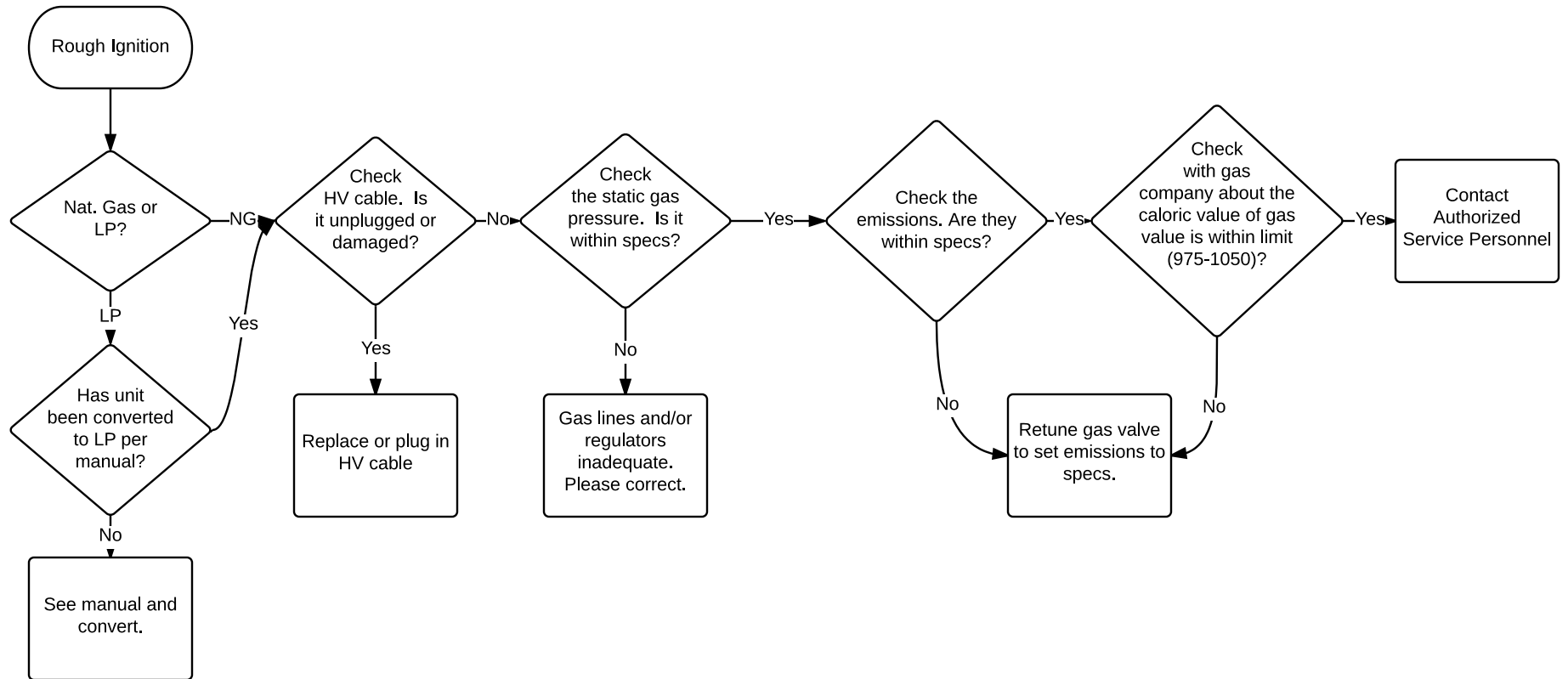

Rumbling

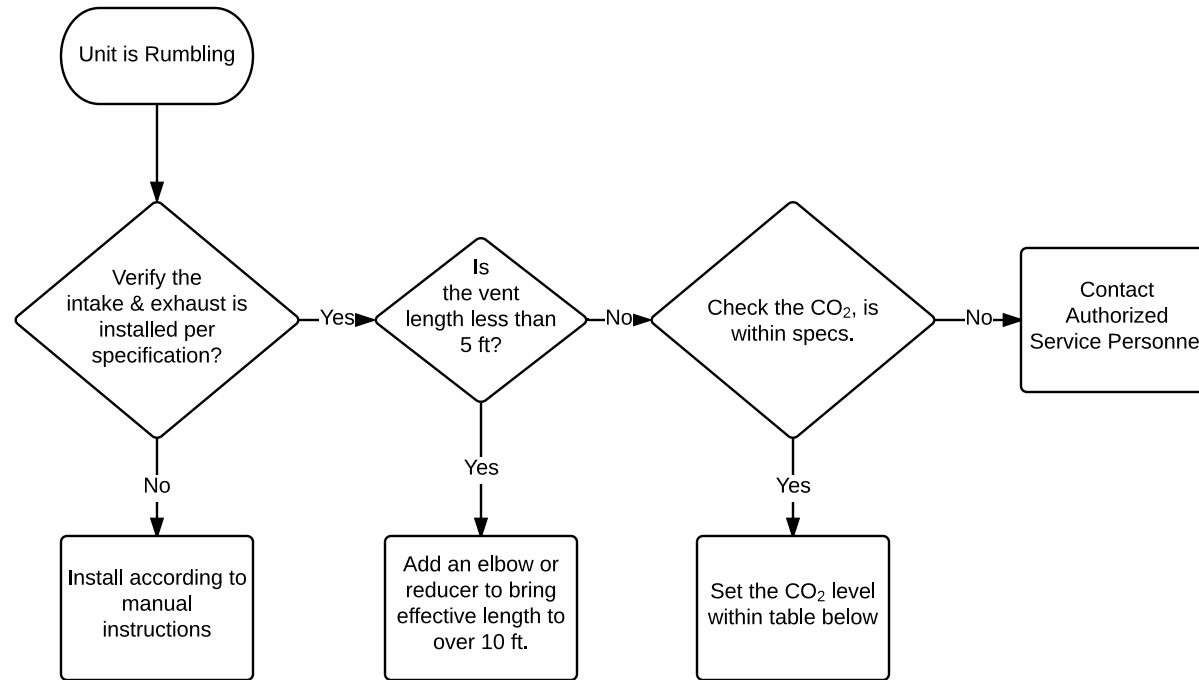

CO ₂ and CO Standards		
Description	CO ₂ Range (%)	Max. CO Level (ppm)
Natural Gas		
High Fire	8.8% to 9.1%	< 200 ppm
Low Fire	8.6% to 8.9%	< 60 ppm
LP Gas		
High Fire	9.0% to 9.8%	< 200 ppm
Low Fire	8.6% to 8.9%	< 60 ppm

Inlet/Outlet/Heat Exchanger/Manifold Inlet/Manifold Outlet/Flue Sensor Open/Fault/Shorted

Temperature Sensor
Open/Fault/Shorted

In the control board, disconnect the J3 connector. Check the corresponding color wire for damage, corrosion and perform continuity from the corresponding color wires to sensor.

Wire color table:
Heat Exchanger - Heat exchanger water outlet temperature sensor (orange wire)
Flue Sensor - Flue temperature sensor (gray wire)
Inlet Sensor - Inlet water temperature sensor (blue wire)
Outlet Sensor - Hot water outlet temperature sensor (green wire)
Manifold Inlet - Manifold Inlet sensor (Black & White)
Manifold Outlet - Manifold Outlet sensor (Orange & Black)

Sensor	Resistance depends on temperature of
Overheat (orange wires)	hot water at the outlet
Flue (gray wires)	Flue gas
Inlet (blue wires)	Inlet cold water
Outlet (green wire)	Hot water outlet
Manifold Inlet (Black & White)	Unit's cold water Inlet
Manifold Outlet (Orange & Black)	Unit's hot water outlet

Temperature (° F)	Sensor Resistance K Ω
50	18
77	10
140	3

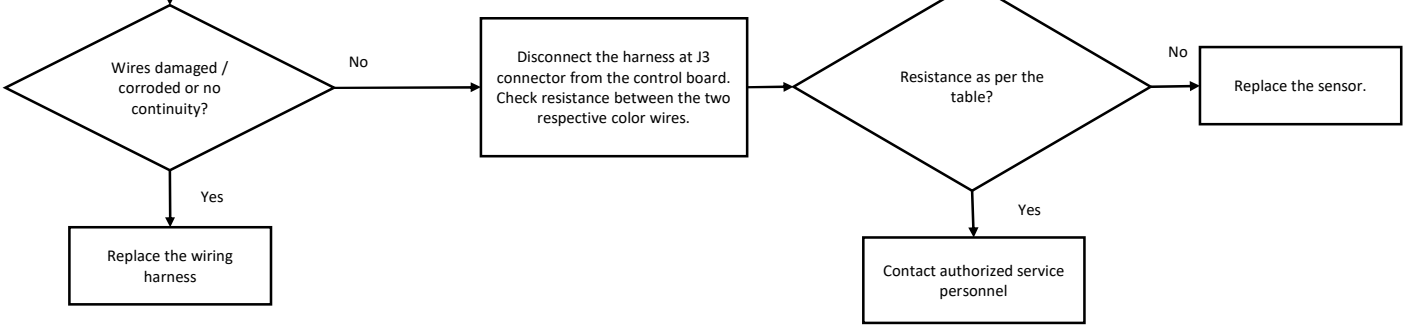
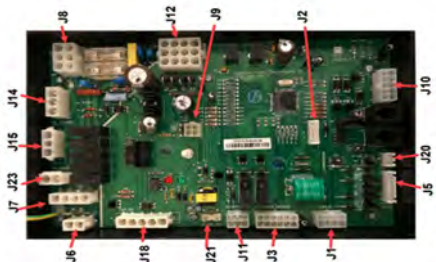

Water Valve Opening Fault Water Valve Closing Fault Water Valve Switch Fault

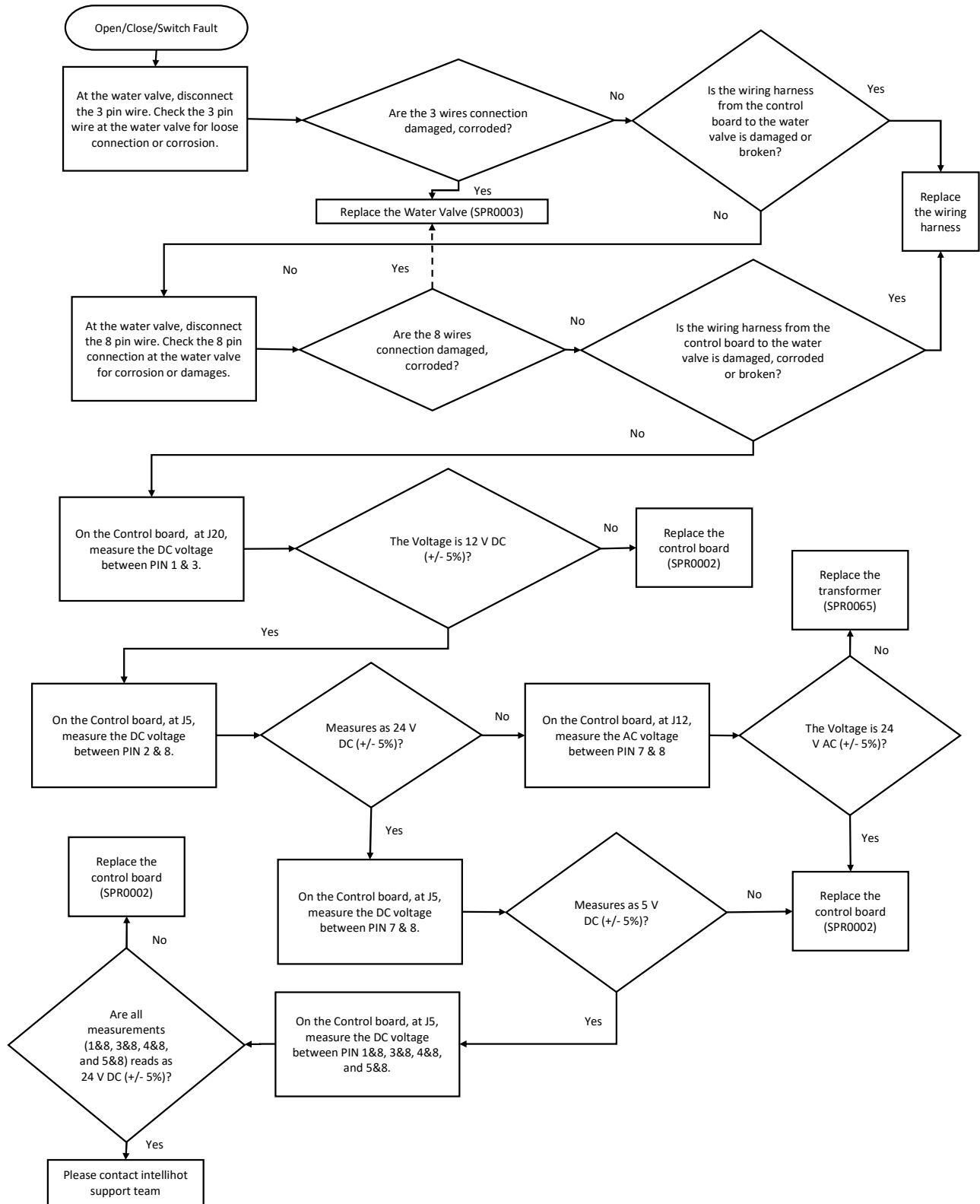

Water Valve Fault

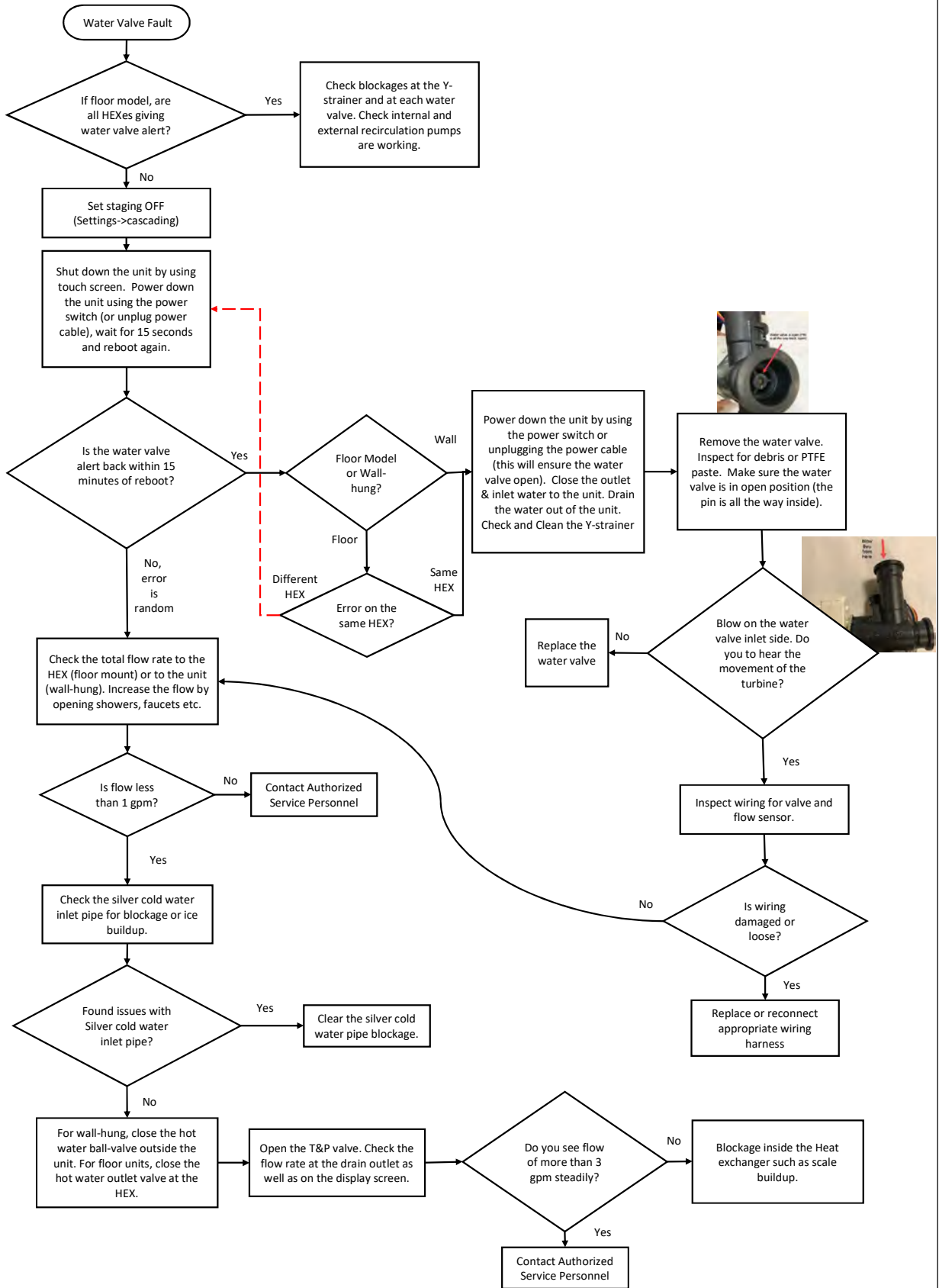

Appendix

BLOWER REPLACEMENT (See Diagram, page 26)

The blower is located on the top of the heat exchanger

- Shut off the gas to the heater
- Shut off power to the heater by unplugging the unit from the 120 VAC outlet
- remove the front panel (three screws at top and three at bottom)
- Unplug the display cable from the pcb (press plastic tab and pull)
- lift up and remove the front display bracket
- Unplug all the wiring connections from the blower (press the tabs and pull)
- remove the gas valve wiring located behind the blower
- Unplug the HV cable from the DSI
- Remove the gas connection at the top isolating the unit's gas supply from the building
- remove phillips screws to remove the aluminum gas fitting at the top the unit
- remove 4 allen screws to remove the aluminum gas adapter fitting
- remove two plastic taps on top of the cabinet to access the screws securing the blower
- remove 4 screws securing the blower from the top using a long screwdriver
- remove the entire blower gas valve assembly from the unit
- remove the gas valve 3 torx screws
- install the gas valve on the new blower
- reverse process to assemble the blower back to the heater
- ensure the gasket is installed between the blower and the top housing
- Install the blower gas valve using 4 screws and a long screw driver
- Install the aluminum gas adapter on top of the gas valve
- Install the gas fitting and secure it using 4 screws to the cabinet
- Install the building gas supply
- Install the blower wiring, HV cable and gas valve wiring
- turn gas supply back on and check for any gas leaks
- turn water on and plug the heater to the outlet

GAS VALVE REPLACEMENT (See Diagram, page 26)

The blower gas valve assembly is located on the top of the heat exchanger

- Shut off the gas to the heater
- Shut off power to the heater by unplugging the unit from the 120 VAC outlet
- remove the front panel (three screws at top and three at bottom)
- Unplug the display cable from the pcb (press plastic tab and pull)
- lift up and remove the front display bracket
- Unplug all the wiring connections from the blower (press the tabs and pull)
- remove the gas valve wiring located behind the blower
- Unplug the HV cable from the DSI
- Remove the gas connection at the top isolating the unit's gas supply from the building
- remove phillips screws to remove the aluminum gas fitting at the top the unit
- remove 4 allen screws to remove the aluminum gas adapter fitting
- remove two plastic taps on top of the cabinet to access the screws securing the blower
- remove 4 screws securing the blower from the top using a long screwdriver
- remove the entire blower gas valve assembly from the unit
- remove the gas valve 3 torx screws
- install the new gas valve on the blower 3 torx screws
- reverse process to assemble the blower back to the heater
- ensure the gasket is installed between the blower and the top housing
- Install the blower gas valve using 4 screws and a long screw driver
- Install the aluminum gas adapter on top of the gas valve (ensure the o-ring is in place)
- Install the gas fitting and secure it using 4 screws to the cabinet
- Install the building gas supply
- Install the blower wiring, HV cable and gas valve wiring
- turn gas supply back on and check for any gas leaks
- turn water on and plug the heater to the outlet

Blower/Gas Valve Exploded View

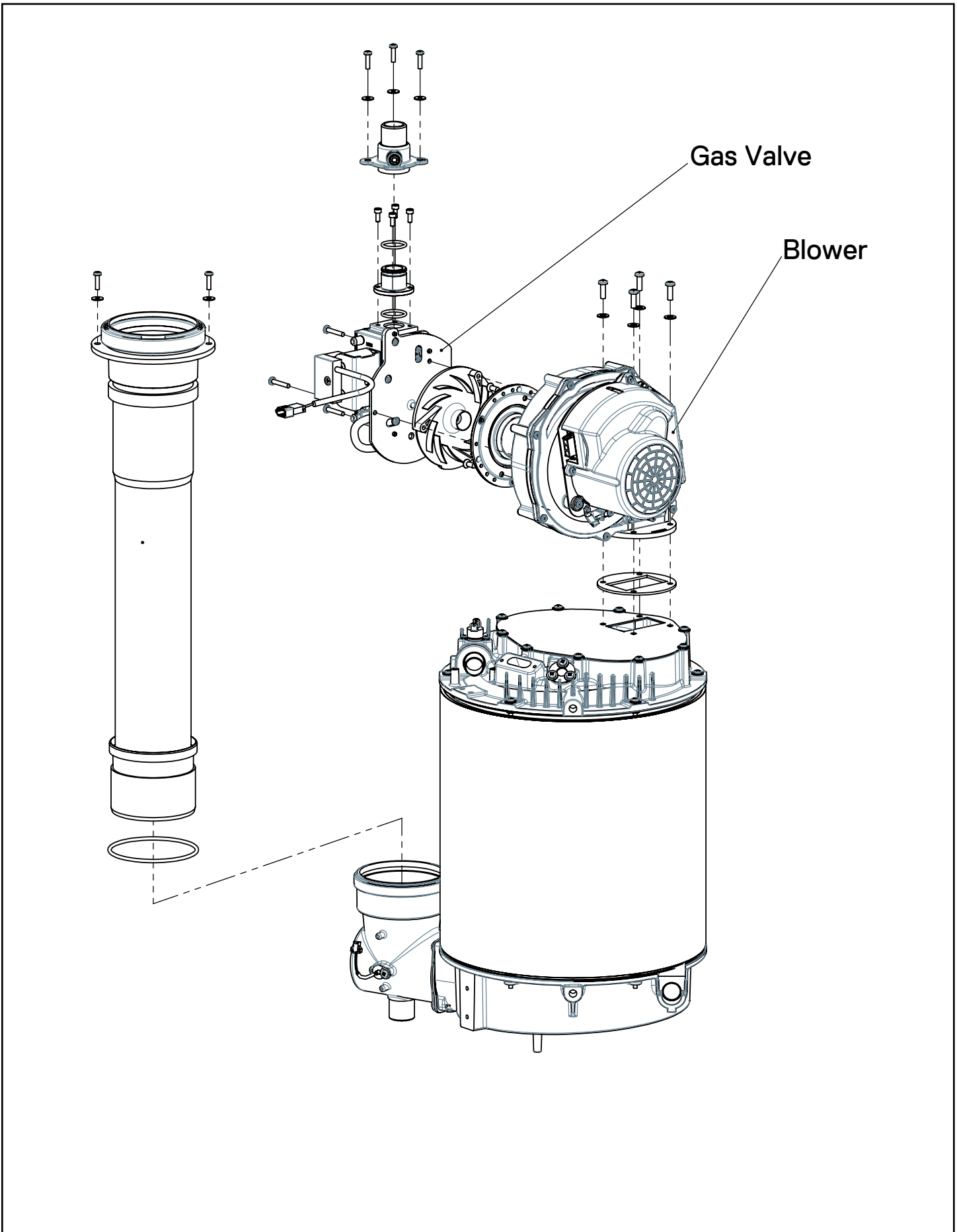

ELECTRODE REPLACEMENT

The electrode is located on the top of the heat exchanger

- Shut off the gas to the heater
- Shut off power to the heater by unplugging the unit from the 120 VAC outlet
- remove the front panel (three screws at top and three at bottom)
- Unplug the display cable from the pcb (press plastic tab and pull)
- lift up and remove the front display bracket
- Unplug the HV cable from the electrode
- Unplug the electrode connection from the controller at connection E12
- Remove the 2 screws & washers securing the electrode
- Remove electrode from HEX assembly.
- Insert new electrode into the HEX assembly, careful to use new probe hole seal
- Fasten the electrode with the 2 screws with washers. Verify that the yellow/green wire is attached beneath the right hand screw.
- Connect the electrode to the controller at connection E12
- Connect the HV cable to the electrode
- turn gas supply back on
- turn water on and plug the heater to the outlet

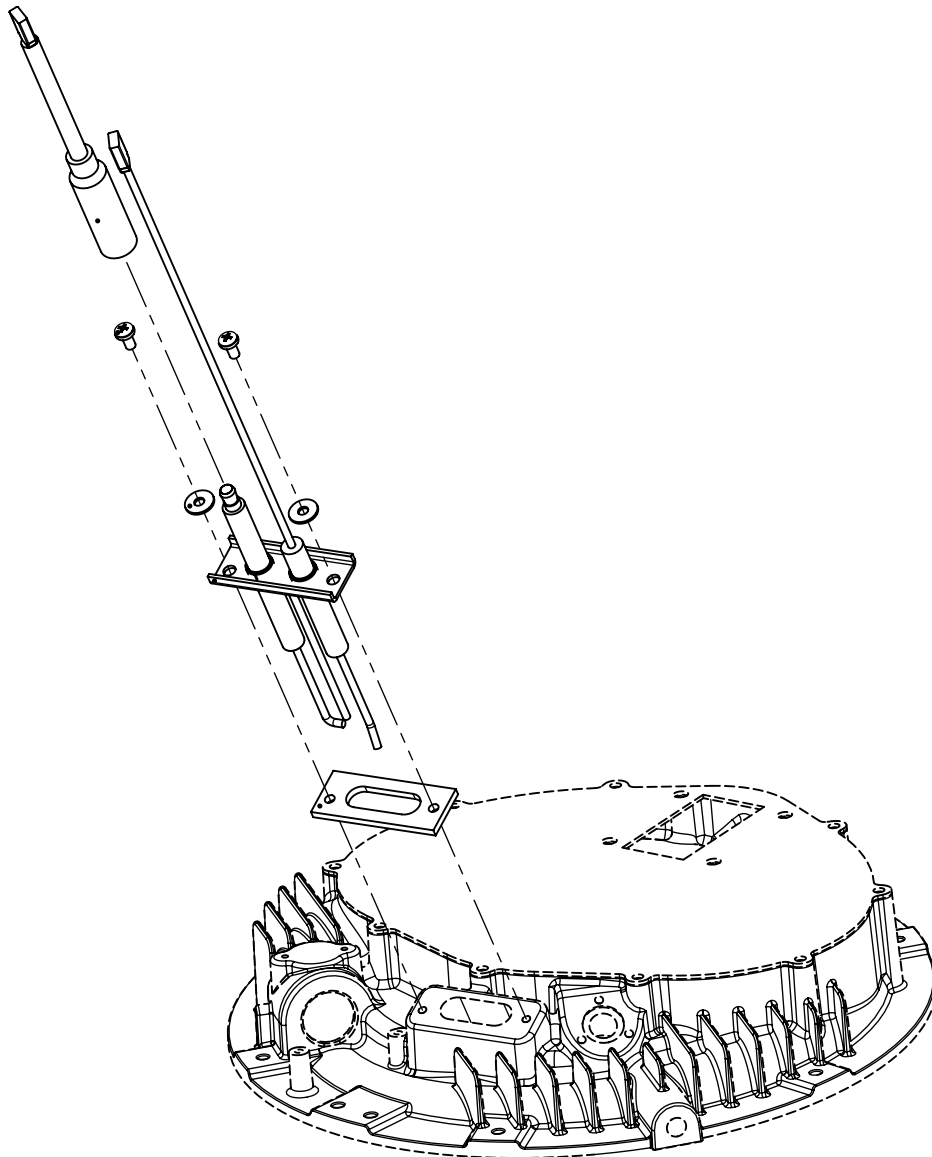

Controller Pin Layout

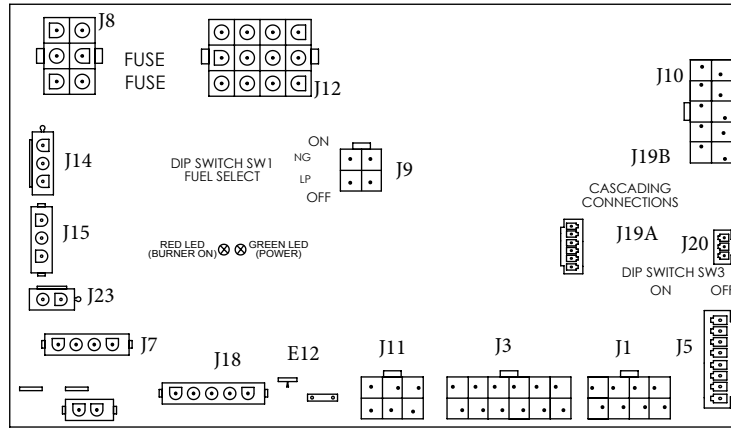

Wiring Diagram (all wall-hung units)

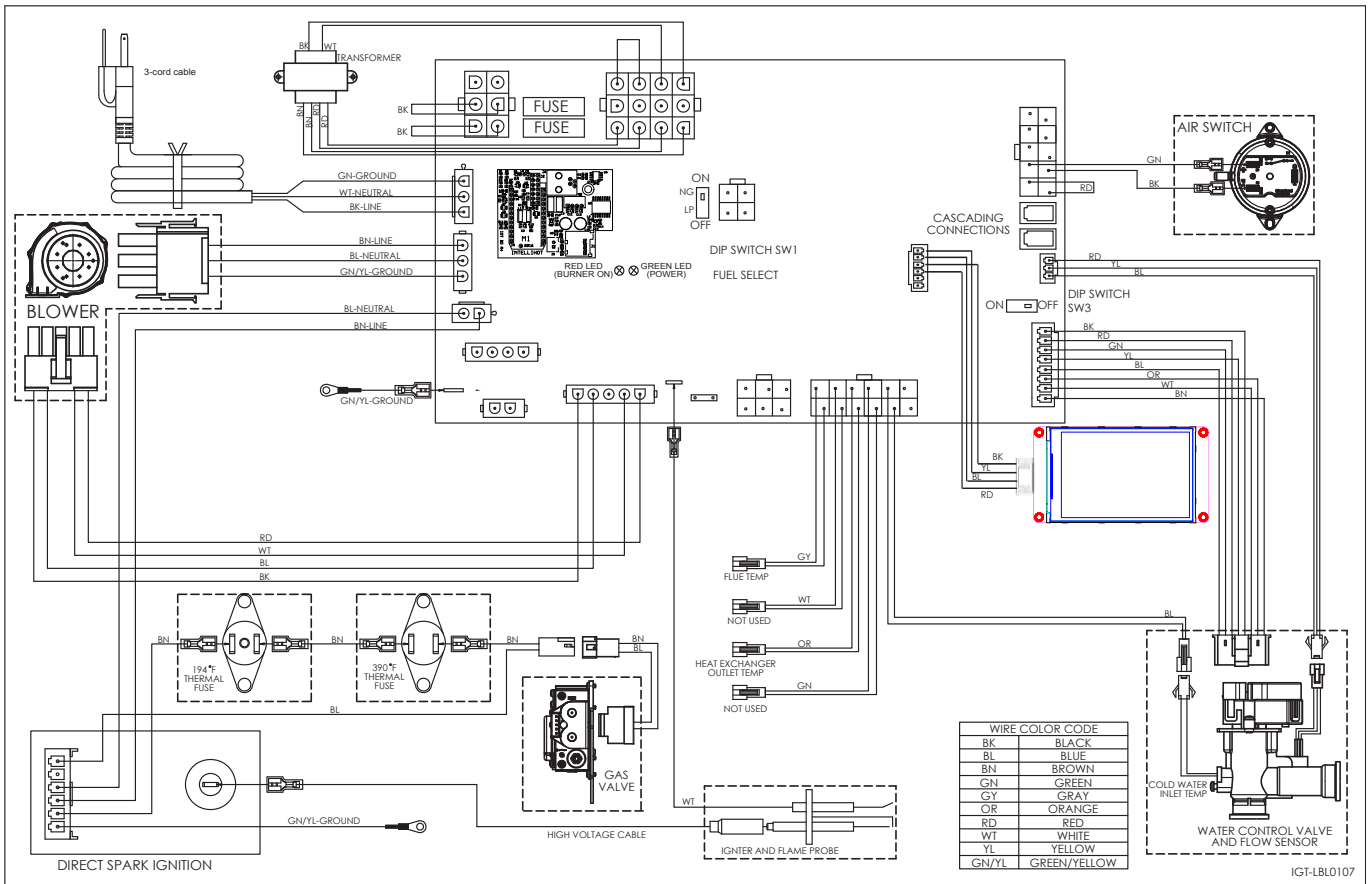

Wiring Diagram (all floor-standing units)

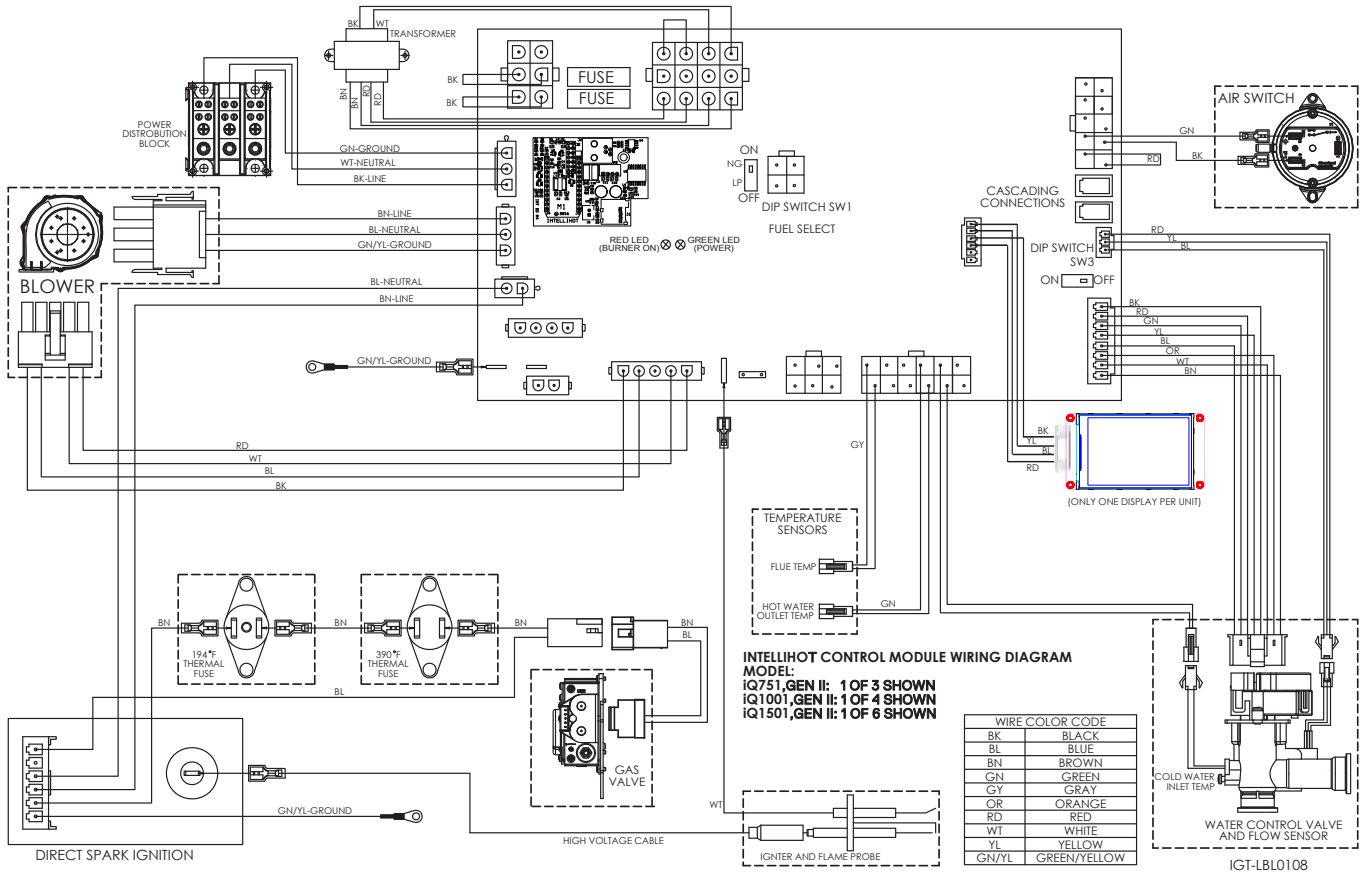

Gas Valve

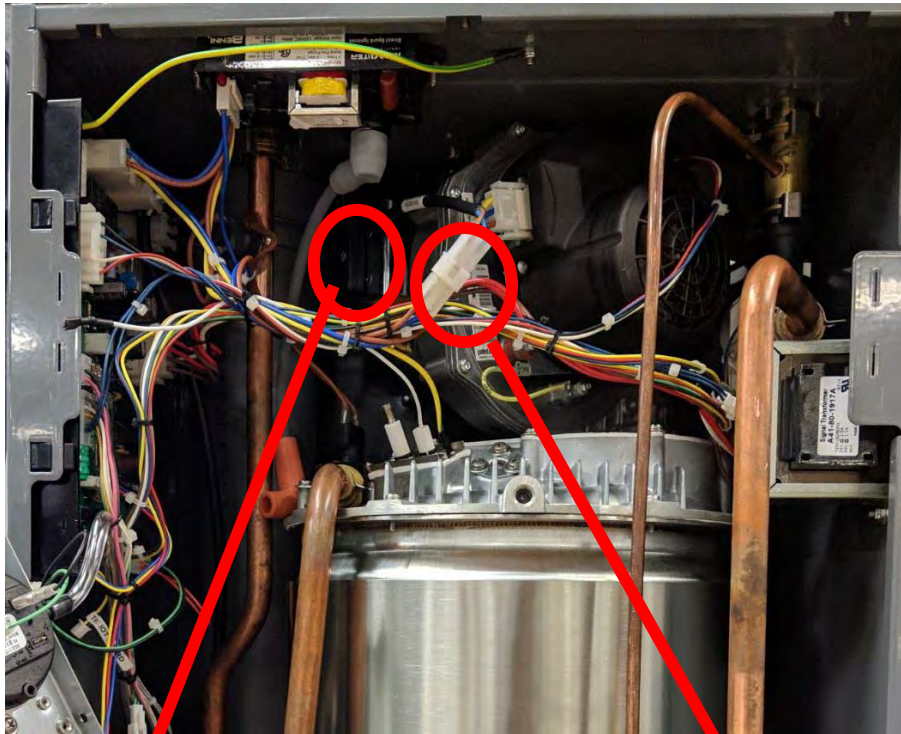

Gas Valve



Blue Gray 120V AC

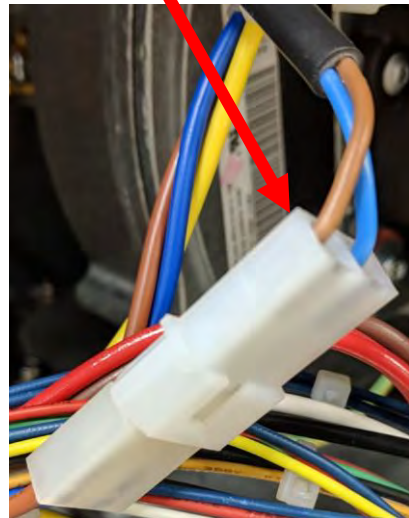

Gas Valve

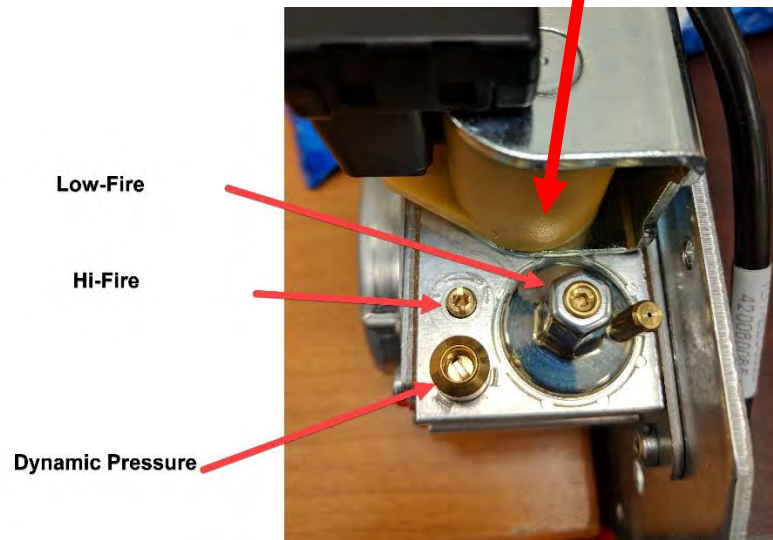
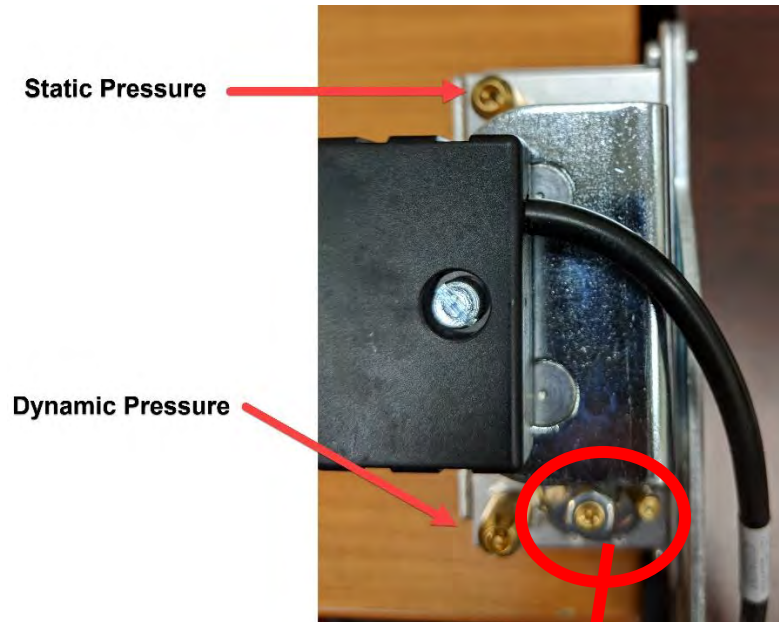

Hi-Fire uses flat screwdriver. Low-fire uses T20 Torx screwdriver.

Resettable overheat switch

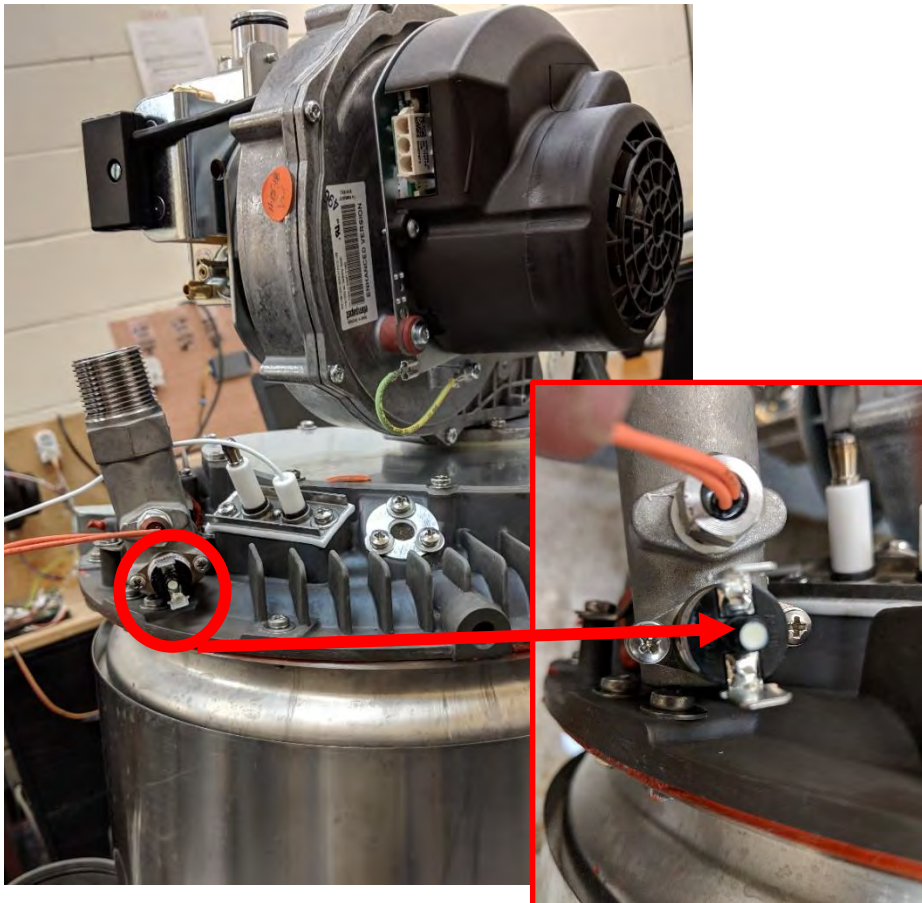
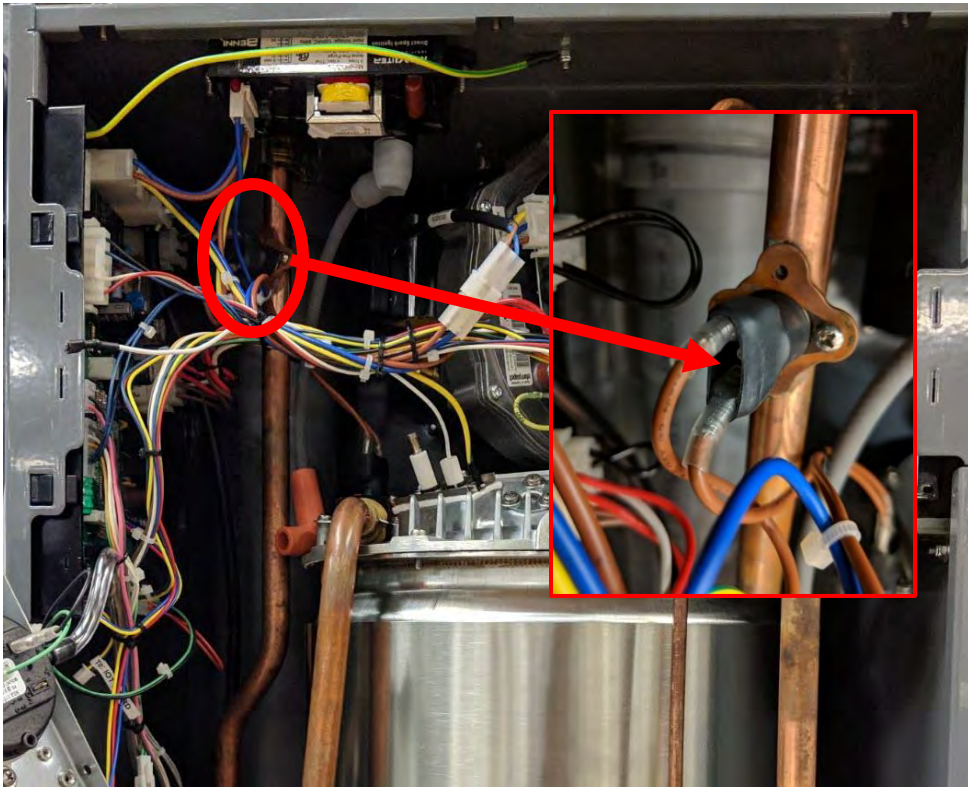

Resettable overhe



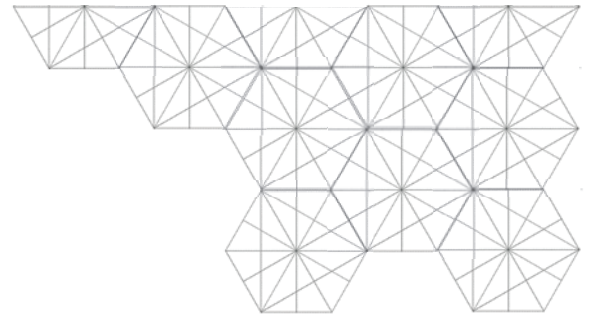

Intellihot

