



WARNING

If the information in these instructions is not followed exactly, a fire or explosion could result causing property damage, personal injury, or death.

- Do not store or use gasoline or other flammable vapors and liquids in the vicinity of this or any other appliance.

WHAT TO DO IF YOU SMELL GAS

- Do not try to light any appliance.
- Do not touch any electrical switch; do not use any phone in your building.
- Immediately call your gas supplier from a neighbor's phone. Follow the gas supplier's instructions.
- If you cannot reach your gas supplier, call the fire department.
- Installation and service must be performed by a qualified installer, service agency, or the gas supplier.

AVERTISSEMENT

Assurez-vous de bien suivre les instructions données dans cette notice pour réduire au minimum le risque d'incendie ou d'explosion ou pour éviter tout dommage matériel, toute blessure ou la mort.

- Ne pas entreposer ni utiliser d'essence ou ni d'autres vapeurs ou liquides inflammables à proximité de cet appareil ou de tout autre appareil.

QUE FAIRE SI VOUS SENTEZ UNE ODEUR DE GAZ

- Ne pas tenter d'allumer d'appareil.
- Ne touchez à aucun interrupteur; ne pas vous servir des téléphones se trouvant dans le bâtiment.
- Appelez immédiatement votre fournisseur de gaz depuis un voisin. Suivez les instructions du fournisseur.
- Si vous ne pouvez rejoindre le fournisseur, appelez le service des incendies.
- L'installation et l'entretien doivent être assurés par un installateur ou un service d'entretien qualifié ou par le fournisseur de gaz.

Installation & Operation Manual

iN199

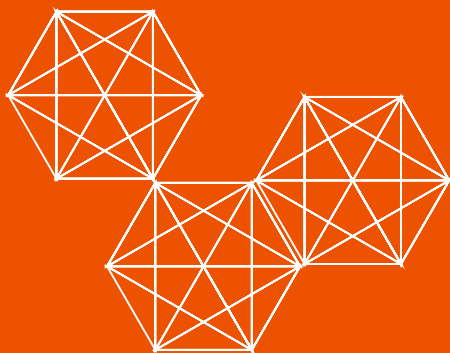

Thank you for purchasing this Intellihot unit.

This unit is designed for years of trouble-free operation, and I urge you to read and follow the instructions in this "Installation & Operation Manual."

Our mission to create a better heating system began in the winter of 2005 when a tank water heater broke down and flooded my basement. By combining the principles of a diesel engine's robustness, robotics intelligence, and marine environment durability, we set out to design a unit from the ground up that would outperform and outlast all others.

Quickly, our goal grew from not just making a better water heater, but creating an intelligent water heating and delivery system. Innovation is our hallmark, and simplicity, efficiency, and durability are at the core of every Intellihot product.

Our products are proudly engineered and built in Galesburg, Illinois. Intellihot has helped commercial customers throughout the nation save thousands of dollars while eliminating downtime. Our talented team of dedicated professionals is ready to assist you and help your business succeed.

I thank you for purchasing our Intellihot products.

Sincerely,

*Sri Deivasigamani
CEO, Intellihot Inc.*

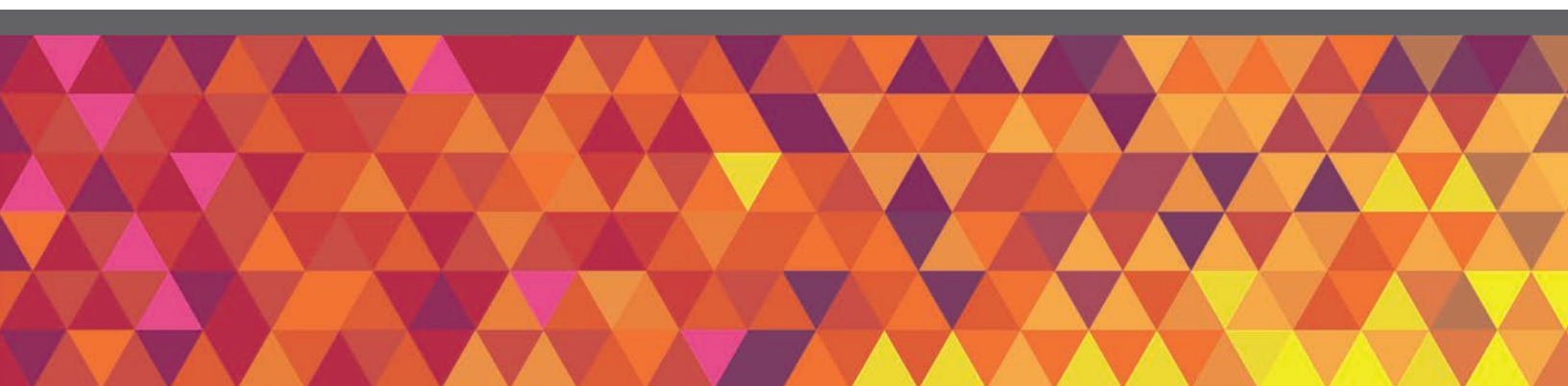
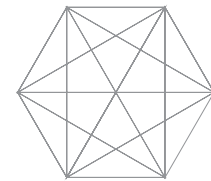
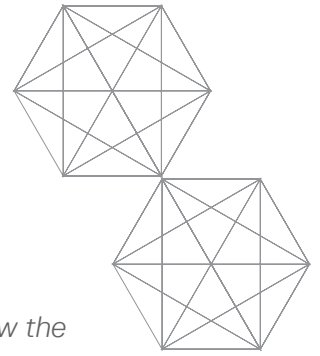

Table of Contents

1. General Information	
1.1 Items Shipped With Water Heater	2
1.2 Serial Number Locations	2
2. Safety	
2.1 Safety Signal Words	3
2.2 Installation Warnings	3
3. Technical Specifications	
3.1 Specifications Chart	5
3.2 Nomenclature	6
3.3 High Elevation Installations	6
3.4 Connection Specifications	7
3.5 Exhaust Gas Standards	7
3.6 Overall Dimensions	8
3.7 Configuration Options	9
4. Quick Reference Installation Guide	
4.1 Install the Water Heater	11
4.2 Pre-Startup Instructions	11
5. Preparation Before Installation	
5.1 Selecting an Indoor Installation Site	13
6. Gas Connection	
6.1 Quick Reference Installation Instructions	14
6.2 Fuel Source	14
6.3 Gas Pressure Requirements	14
6.4 Gas Pressure Regulator	14
6.4.1 Venting of Gas Supply Regulators	15
6.5 Length of Gas Supply Line	15
6.6 Gas Piping Material	15
6.7 Determine Correct Gas Pipe Diameter	15
6.8 Gas Pipe Drip Leg and Shut-off Valve	15
6.9 Connecting Gas Line to Unit	16
6.10 Gas Pipe Sizing Tables	17
7. Air Intake Inlet and Exhaust Gas Outlet Pipe Connections	
7.1 Quick Reference Installation Guide	19
7.2 Typical Single Unit Air Intake Inlet and Exhaust Gas Outlet Pipe Installation	19
7.3 Two Pipe Vent System (Direct Vent)	20
7.3.1 Single Unit Configurations	20
7.3.2 Multiple Units Configurations	21
7.3.3 Side Wall Air Intake Inlet and Exhaust Gas Outlet Pipe Termination	21
7.3.4 Roof Air Intake Inlet and Exhaust Gas Outlet Pipe Termination	22
7.4 Single Pipe Venting System	22
7.4.1 Single Unit	22
7.4.2 Multiple Units	23
7.5 Combustion Air Requirements	24
7.6 Intake Air Inlet and Exhaust Gas Outlet Pipe Diameter and Length	24
7.7 Venting Clearance Specifications	25
7.8 Exhaust Gas Outlet Pipe Materials	26
7.9 Air Intake Inlet Pipe Vent Materials	26
7.10 Recommended Exhaust-Gas Outlet Pipe Transitions	27
8. Water Connections	
8.1 Quick Reference Installation Instructions	28
8.2 Hot Water Connection	28
8.3 Cold Water Connection	29
8.4 Condensate Drain Line	29
9. Electrical Power	
9.1 Electrical Recommendations	30
9.2 Connection Instructions	30
10. Adjusting CO₂ Level	
10.1 General Information	31
10.2 Adjustment Procedure	31
11. Natural Gas to Propane Conversion	
11.1 General Information	34
11.2 Conversion Procedure	34
12. Operation	
12.1 Control Panel	36
12.2 Turning Water Heater ON and OFF	36
12.3 Setting the Time	37
12.4 Adjusting the Water Temperature	37
12.5 Security	38
12.5.1 Setting Passcode Protection	38
12.5.2 Changing Passcode	39
12.5.3 Forgot Passcode	40
12.6 Unit Overview	40
12.7 Life Screen	41
12.8 Unit Information	42
12.9 More Screens	43
12.9.1 Cellular	43
12.9.2 Error History	44
12.9.3 telliCare Service (Subscribe at Startup)	44
13. Connecting Multiple Units	
13.1 General Information	47
13.2 Installation Procedure	47
13.3 Venting for Multiple Units	48
14. Maintenance	
14.1 Maintenance-Free Circulation Pump	49
14.2 Air Filter	49
14.2.1 Inspection	49
15. Wiring Diagrams and Troubleshooting	
15.1 Operational Flow Chart	51
15.2 Complete Wiring Diagram (all models)	52
15.3 Troubleshooting Guide	53
16. Serviceable Parts	
16.1 Display	59
16.2 Control Board	60
16.3 Water Circuit (top side)	61
16.4 Water Circuit (bottom side)	62
16.5 Exhaust	63
16.6 Heat Exchanger	64
16.7 Heat Exchanger (top side)	65
16.8 Miscellaneous	66
17. Requirements for State of Massachusetts	
17.1 Notice Before Installation	67
18. Warranty	
18.1 Warranty	68
19. Product Warranty Registration	
19.1 Warranty	71

WARNING

If the information in these instructions is not followed exactly, a fire or explosion could result causing property damage, personal injury, or death.

- Do not store or use gasoline or other flammable vapors and liquids in the vicinity of this or any other appliance.

WHAT TO DO IF YOU SMELL GAS

- Do not try to light any appliance.
 - Do not touch any electrical switch; do not use any phone in your building.
 - Immediately call your gas supplier from a neighbor's phone. Follow the gas supplier's instructions.
 - If you cannot reach your gas supplier, call the fire department.
- Installation and service must be performed by a qualified installer, service agency, or the gas supplier.

AVERTISSEMENT

Assurez-vous de bien suivre les instructions données dans cette notice pour réduire au minimum le risque d'incendie ou d'explosion ou pour éviter tout dommage matériel, toute blessure ou la mort.

- Ne pas entreposer ni utiliser d'essence ou ni d'autres vapeurs ou liquides inflammables à proximité de cet appareil ou de tout autre appareil.

QUE FAIRE SI VOUS SENTEZ UNE ODEUR DE GAZ

- Ne pas tenter d'allumer d'appareil.
 - Ne touchez à aucun interrupteur; ne pas vous servir des téléphones se trouvant dans le bâtiment.
 - Appelez immédiatement votre fournisseur de gaz depuis un voisin. Suivez les instructions du fournisseur.
 - Si vous ne pouvez rejoindre le fournisseur, appelez le service des incendies.
- L'installation et l'entretien doivent être assurés par un installateur ou un service d'entretien qualifié ou par le fournisseur de gaz.

This product complies with ANSIZ21.10.3 (2011) / CSA 4.3 Gas Water Heater. For use as potable water heating.



DANGER



To avoid product damage, personal injury, or even possible death, carefully read, understand, and follow all the instructions in this *Installation & Operation Manual* before installing this product. Improper installation, adjustment, alteration, or maintenance can cause injury, loss of life, and/or property damage. This water heater should be installed and serviced by a qualified technician. The lack of proper service can result in a dangerous condition.

Due to Intellihot's policy of continuous product improvement and technology, the design, technical specifications, or both in this manual are subject to change without notice.

This manual contains safety information, installation instructions, and maintenance procedures. It must be left with the homeowner or placed near the water heater in a noncombustible location. The customer should retain this manual for future reference.

Contact Information

Call us, your dealer, first if you have any questions about this product. We can help answer questions about installation, operation, or if there are damaged or missing parts when unpacking this unit from the shipping box.



Dealer Contact Information

1. General Information

1.1 Items Shipped With Water Heater

The items shown in the illustration are shipped loose with the water heater.

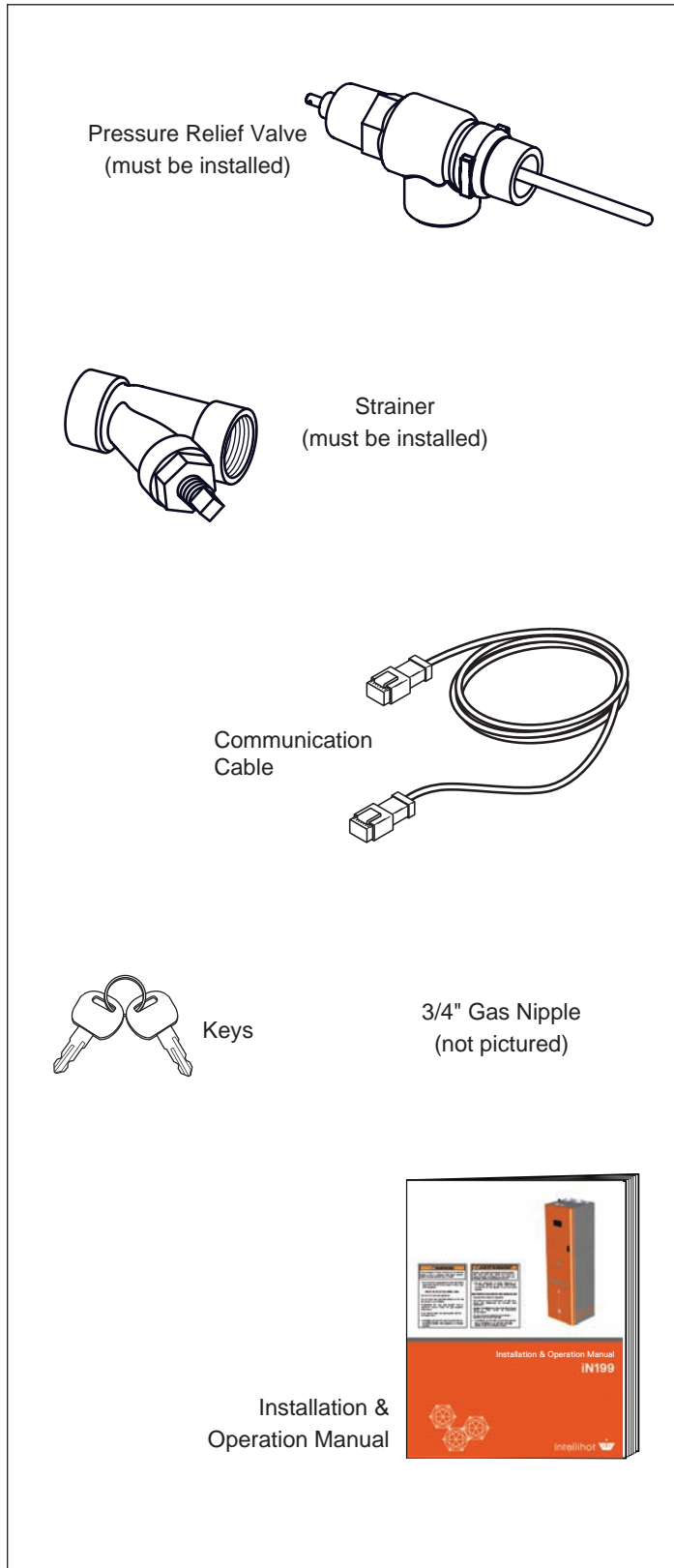

1.2 Serial Number Locations

The unit's serial number is located on the left side of the unit. Provide this serial number when inquiring about service or warranty solutions.

Unit Serial Number: _____

Date of Installation: ___ / ___ / _____

2. Safety

2.1 Safety Signal Words

DANGER

Indicates an imminently hazardous situation which, if not avoided, results in death or serious injury. This signal word is limited to the most extreme situations.

WARNING

Indicates a potentially hazardous situation which, if not avoided, could result in death or serious injury.

CAUTION

Indicates a potentially hazardous situation which, if not avoided, might result in minor or moderate injury.

NOTICE

Indicates that equipment or property damage can result if instructions are not followed.

SAFETY INSTRUCTIONS

Safety instructions (or equivalent) signs indicate specific safety-related instructions or procedures.

Note: Contains additional information important to a procedure.

2.2 Installation Warnings

WARNING

DO NOT use this water heater for any purpose other than heating water.

Read, understand, and follow the *Installation & Operation Manual*, including all warnings and precautions, before operating this water heater. If you do not follow these instructions exactly, a fire or explosion can result, causing property damage, personal injury, or loss of life.

Follow all local codes and the most recent edition of the National Fuel Gas Code (ANSI Z223.1/NFPA 54) in the USA or the Natural Gas and Propane Installation Code in Canada (CSA B149.1).

This water heater must be installed by a licensed plumber, gas fitter, or professional service technician. Installation by unqualified person(s) voids the warranty.

This water heater is designed for operations at outlet temperature(s) not in excess of 190°F (88°C).

DANGER

A. This water heater does not have a pilot light. It is equipped with an ignition device which automatically lights the burner. Do not try to light the burner manually.

B. **BEFORE OPERATING**, smell all around the water heater area for gas. Be sure to smell near the floor because some gas is heavier than air and settles on the floor.

WHAT TO DO IF YOU SMELL GAS:

- Do not try to light any appliance.
- Do not touch any electric switch; do not use any phone in your building.
- Immediately call your gas supplier from a neighbor's phone. Follow the gas supplier's instructions.
- If you cannot reach your gas supplier, call the fire or police department.

C. Use only your hand to turn the manual gas shut-off valve. Never use tools. If the manual gas shut-off valve does not turn by hand, don't try to repair it. Call a qualified service technician. Force or attempted repair can result in a fire or explosion.

WARNING

DO NOT use or store flammable liquids around the water heater, including gasoline, oils, spray paints, etc.

DO NOT operate this water heater unless it is properly vented to the outside (the exhaust vent piping must be connected from the unit directly to the outside). Improper venting can cause a build-up of carbon monoxide, which can result in brain damage or death. Exhaust gases must be completely expelled out of the building.

This water heater is factory preset for **NATURAL GAS** but can be field-converted for use with propane. For propane conversion, refer to the Propane (LPG) Conversion section of this manual. Connecting the water heater to any other gas supply can result in property damage, serious injury, or even death.

This water heater is suitable for use in potable water heating applications. The cold and hot water fittings on the top of the water heater **MUST NOT** be connected to any heating system.

The water heater temperature is factory set to 120°F (49°C). Hot water temperatures above 125°F can cause severe burns instantly or death from scalds. If the proposed water heater outlet temperature is to be set above 125°F, installation of a thermostatically controlled (or temperature-limiting) mixing valve is recommended for all hot water going to faucets to avoid the risk of scalding. Examples include commercial applications where 140°F (60°C) is often needed or if the space heating temperature required is higher than the domestic hot water. Always check the temperature of the hot water before bathing, showering, washing, etc.

Protect against snow and debris accumulation around the vent terminations. Regularly inspect the exhaust vent pipe and the air intake pipe to ensure they remain clear from obstructions at all times.

⚠ CAUTION

Make sure you know the location of the gas shut-off valve and how to operate it. Immediately close the gas shut-off valve if the water heater is subjected to fire, overheating, flood, physical damage, or any other damaging condition that might affect the operation of the unit. Have the water heater checked by a qualified technician before resuming operation.

If the water quality is known to have high acidity, high hardness, or both, water treatment is recommended. Consult the local water authority.

SAFETY INSTRUCTIONS

DO NOT use this appliance if any part has been under water.

DO NOT reverse the cold water and gas connections as this damages the gas valve.

DO NOT overtighten fittings as damage might occur, causing internal leakage.

Locate the appliance in an area where leakage within the unit or at its connections does not result in damage to the surrounding area. The manufacturer is not responsible for any damage resulting from leaking if adequate drainage is not provided.

3. Technical Specifications

3.1 Specifications Chart

Technical Data	iN199 Specification
Type	Indoor, Floor-Mounted
Fuel	Preset for natural gas but convertible to propane
Minimum Input (BTUs/hour)	30,000
Maximum Input (BTUs/hour)	199,950
Maximum Output (BTUs/hour)	195,950
Thermal Efficiency	98%
Turn Down Ratio (TDR)	6.7:1
Water Inlet / Outlet Connection	1-1/2" NPT
Gas Inlet Connection	1-1/2" NPT (3/4" w/nipple)
Condensate Drain Connection	3/4" PVC
Maximum Condensate Flow Rate (GPM)	1.4
Unit dimensions H X W X D (inches)	67.5 X 20 X 20 (15.6 cu. ft)
Service Clearances	4" on the back, 6" on the top, 12" on the front, and 6" on the sides
Unit weight (lbs)	273
Shipping Crate Dimensions H X W X D / Weight	27 X 29.5 X 85 (Inches) / 373 (LBS)
Venting Type	Direct Vent (2 pipe – air intake and exhaust gas outlet), Power Vent (1 pipe – exhaust gas only)
Venting Materials (USA)	Sch. 40 PVC, Sch. 80 CPVC, Polypropylene, Stainless Steel (AL29-4C)
Venting Materials (Canada)	Type BH Gas Vent Classes: II A (PVC), II B (CPVC), II C (Polypropylene), I (AL294C SS)
Venting Size (Diameter)	3"
Max 8" Vent Length – Single Pipe/Power Vent	195' *
Max 8" Vent Length – Two Pipe / Direct Vent	95' *
* Venting Note: From the maximum length above, deduct 5 ft. per 90° elbow and 2 ft. per 45° elbow.	
Ignition	Electronic Spark Ignition
Temperature Range	100°F – 190°F
Temperature Stability	+/- 4°F (when on demand)
Installation Location Ambient Temperature	40°F – 130°F
Safety	Flame Rod, Thermal Fuse, Overheat Prevention Device, Fan Speed Monitor, Flue Temperature Monitor, Blocked Vent Detector, Dual Flame Sensing
Water Pressure Min / Max (PSI)	30/150
NG/LP- Min. Static Gas Pressure (Full Fire)	2.5" WC (set regulators to 8" NC for NG or 11" for LP)
NG/LP - Maximum Static Gas Pressure	14" WC
Gas Pressure for Adjustments	8" WC for Natural Gas, 11" WC for Propane
Electrical	120V AC, 60 Hz
Power Consumption	Max 9.5 Amps, 16W (Standby)
Internal Water Volume (gallons)	1
Features and Approvals	iN199
Cascading	Masterless, 4-Unit, Automatic Rotation
Common Venting	Yes, Up to 4 Units
Heat Exchanger	Expandable, Stainless 316L
Appliance Certification to ANSI Z21.10.3	ETL
SCAQMD (Pending)	Ultra Low Nox (under 20 PPM)
Performance	Specification
Hot Water Output (45°F Rise)	8.7
Hot Water Output (70°F Rise)	5.6
Hot Water Output (90°F Rise)	4.4
Hot Water Output (100°F Rise)	3.9
Hot Water Output (140°F Rise)	2.8
Warranty	Heat Engine Coil - 6 years, All Other Parts - 1 year
Note: Due to continuous product improvements, the design and technical specifications are subject to change without notice.	

3.2 Nomenclature

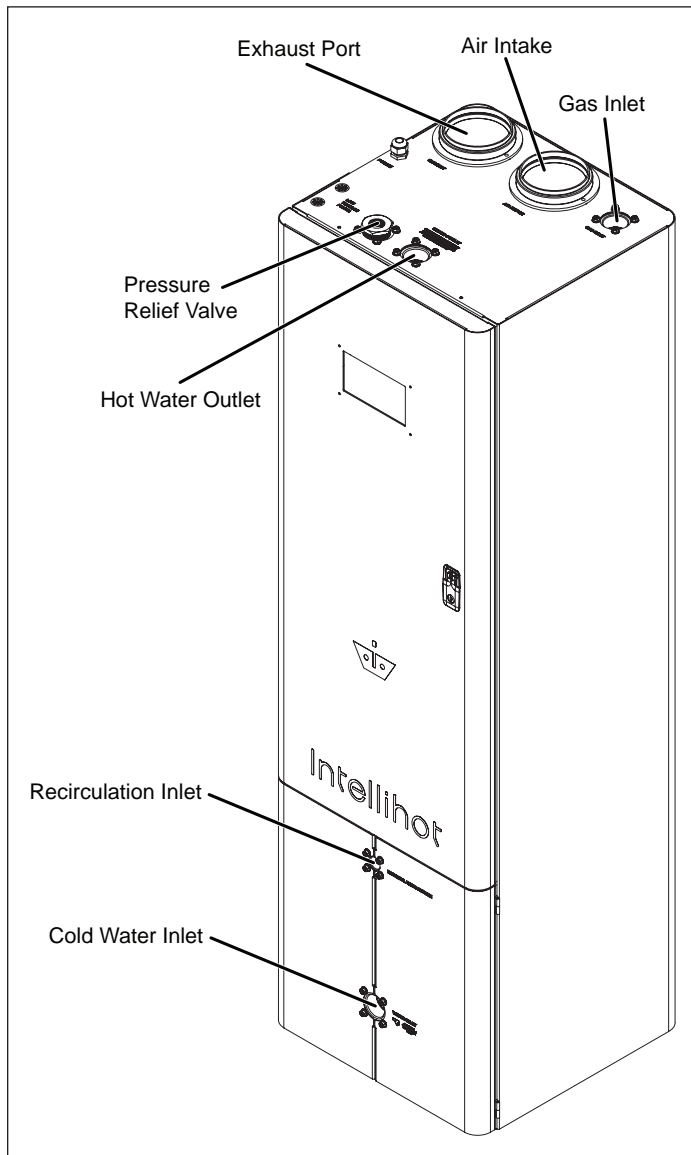

3.3 High Elevation Installations

For operation at elevations above 2,000 feet, the hot water delivery capacity should be reduced by 4% for each 1,000 feet above sea level.

Clearance Requirements

For the water heater to operate properly and efficiently, the clearances specified in the table below are recommended.

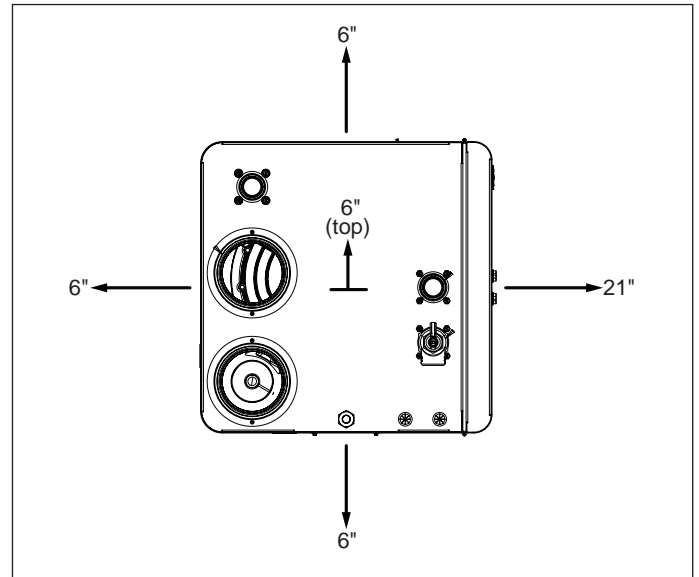

Service Clearances: If multiple units are installed, complete the electrical connections first before making all other connections (gas, water, supply air, exhaust, and condensate). This enables the 1" side to side clearances mentioned in 3.1 Specifications Chart.

Location	Required		Recommended Service Clearance ¹
	From Combustibles	From Non-Combustibles	
Top	6" (15 cm)	2" (51 cm)	6" (15 cm)
Back	5/8" (16 mm)	5/8" (16 mm)	4" (10 cm)
Sides	1" (25 mm)	1/2" (13 mm)	6" (15 mm)
Front	2" (5 cm)	2" (5 cm)	21" (53 cm)
Bottom	0" (0 mm)	0" (0 mm)	0" (0 mm)

¹ Service clearances are recommended dimensions to allow for normal service of the unit.

3.4 Connection Specifications

Connections	
Description	Specification
Gas Supply Inlet Connection	3/4" NPT
Water Supply Inlet Connection	1-1/2" NPT
Heated Water Outlet Connection	1-1/2" NPT
Air Intake Inlet	3" Polypropylene
Condensate Drain Connection	3/4"
Power Supply	120V AC Power

3.5 Exhaust Gas Standards

CO ₂ and CO Standards		
Description	CO ₂ Range (%)	Max. CO Level Particles Per Million (ppm)
Natural Gas		
High Fire	9.1% to 9.3%	< 200 ppm
Low Fire	9.1% to 9.3%	< 60 ppm
Propane Gas		
High Fire	10.1% to 10.5%	< 200 ppm
Low Fire	10.1% to 10.5%	< 60 ppm

3.6 Overall Dimensions

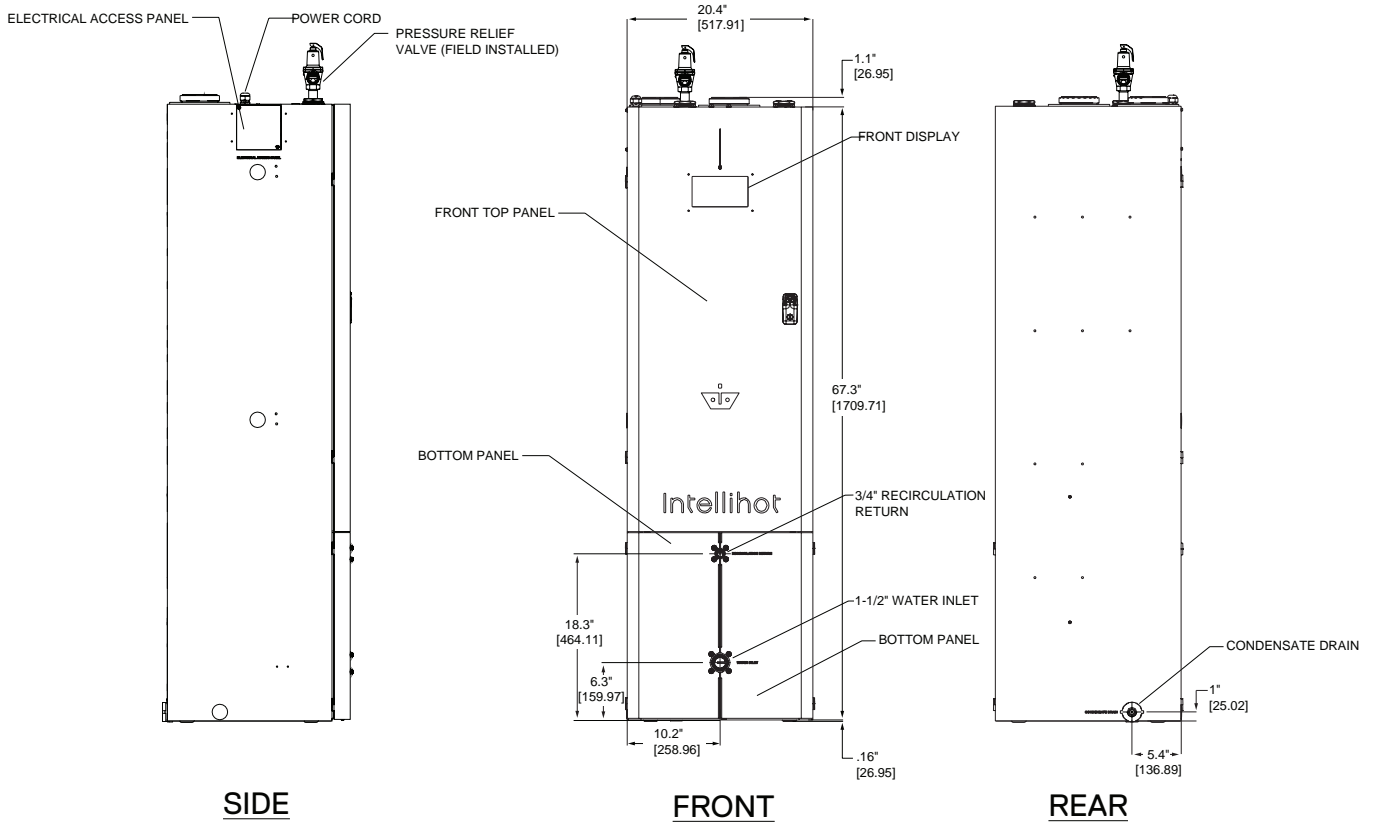
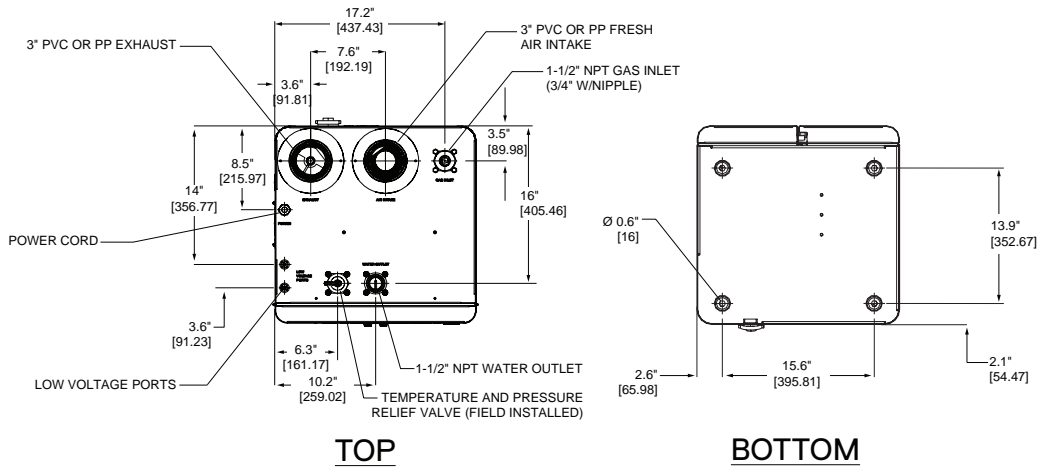

3.7 Configuration Options

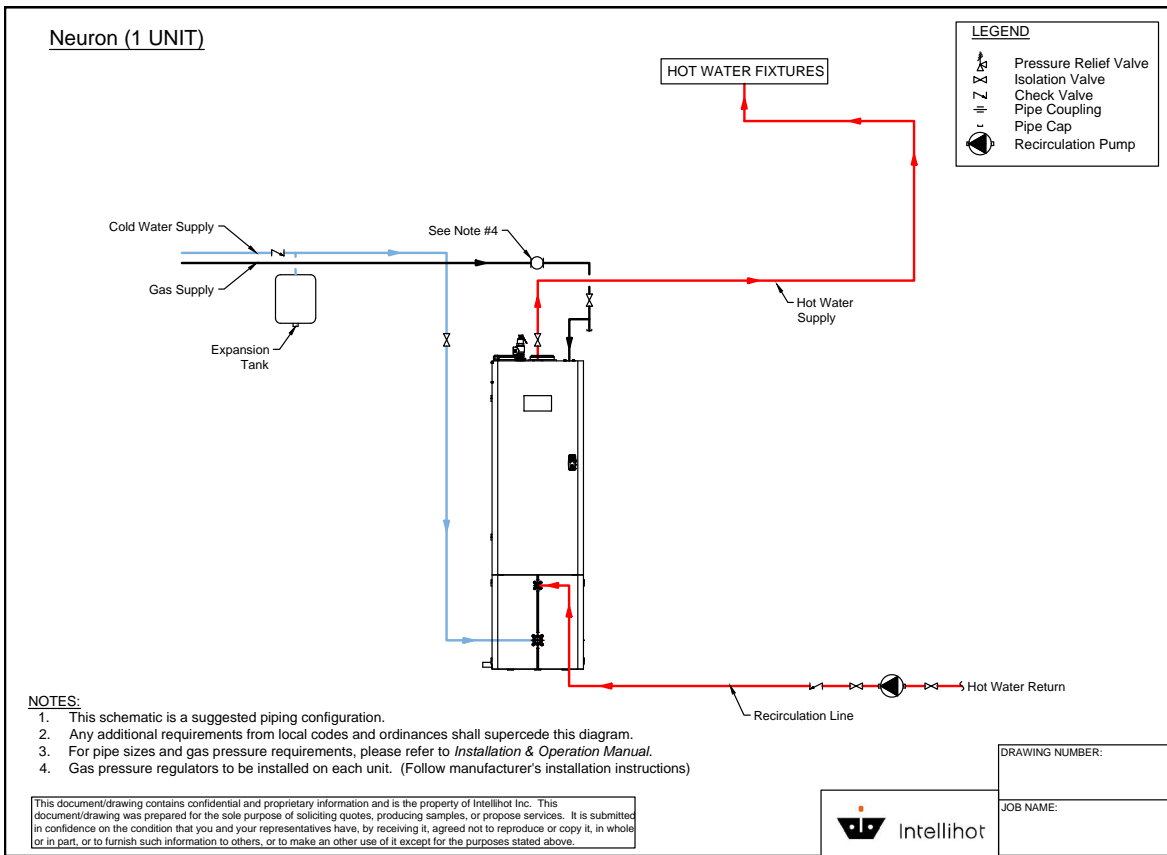

System with no storage tank and without mixing valve.

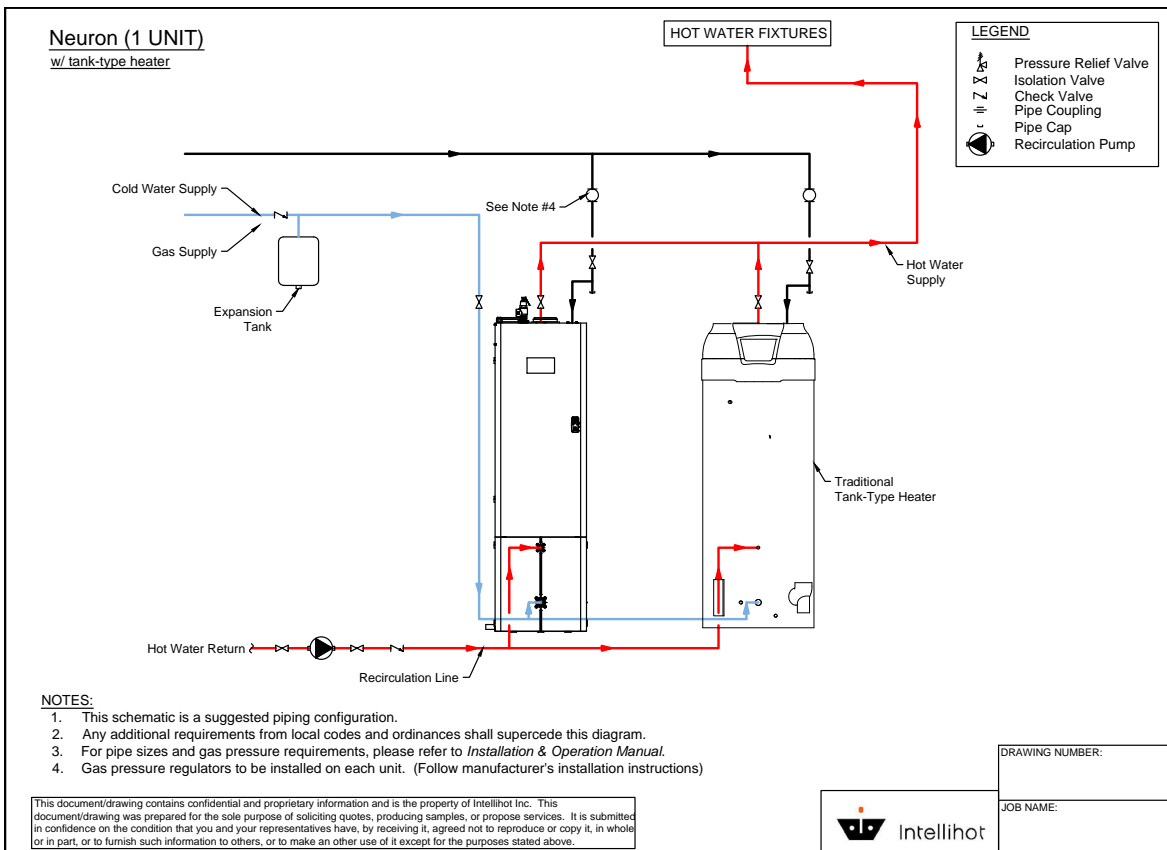

System with mixing valve but no storage tank.

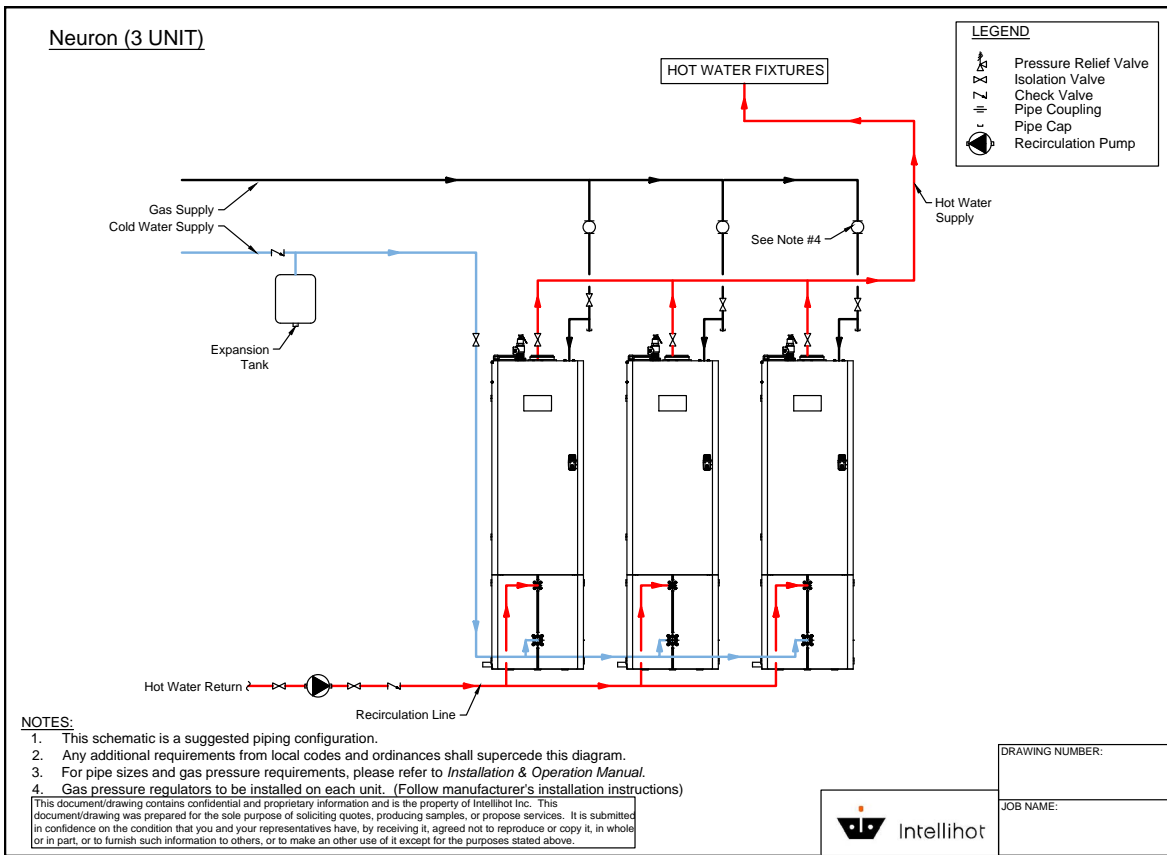

Multiple unit system with mixing valve but no storage tank.

4. Quick Reference Installation Guide

4.1 Install the Water Heater

When installing the water heater, follow all local building codes and the current edition of the National Fuel Gas Code (ANSI Z223.1/NFPA 54) in the USA, or National Gas and Propane Installation Code (CAN/CGA B149.1) in Canada.

Note: For water heater installations in Massachusetts, refer to section "16. Serviceable Parts" on page 59.

1. Select an installation location.
For an interior or exterior location, refer to section "5. Preparation Before Installation" on page 13.
2. Check the quality of the water to determine if additional treatment is beneficial to the function and efficiency of the water heater. For additional information, refer to section "5. Preparation Before Installation" on page 13.
3. Make all necessary gas connections.
For additional information, refer to section "6. Gas Connection" on page 14.
4. Make all necessary venting connections.
For additional information, refer to section "7. Air Intake Inlet and Exhaust Gas Outlet Pipe Connections" on page 19.
5. Make all necessary water connections.
For additional information, refer to section "8. Water Connections" on page 28.
6. Make all necessary electrical connections. For additional information, refer to "9. Electrical Power" on page 30.

Note: For additional electrical protection, a surge protector is recommended. Damage caused by power surges is not covered by the warranty.
7. If necessary, convert the water heater from the factory preset of using natural gas to using propane. Refer to section "11. Natural Gas to Propane Conversion" on page 34 for the instructions.
8. As part of the propane conversion process, the CO₂ and CO values must be adjusted. This process is also required when installing the water heater at altitudes over 8,000 feet. This procedure should be completed only by a qualified technician. To check, adjust, or both the CO₂ and CO levels, refer to "10. Adjusting CO₂ Level" on page 31.
9. If connecting multiple units together, refer to "13. Connecting Multiple Units" on page 47.
10. Fill out the Warranty Card and return it to Intellihot.
For a copy of the card, go to "19. Product Warranty Registration" on page 71.

4.2 Pre-Startup Instructions

1. Recheck the hot and cold water lines, the gas line, condensate drain line, the fresh air intake, and exhaust vent to make sure they are properly connected.

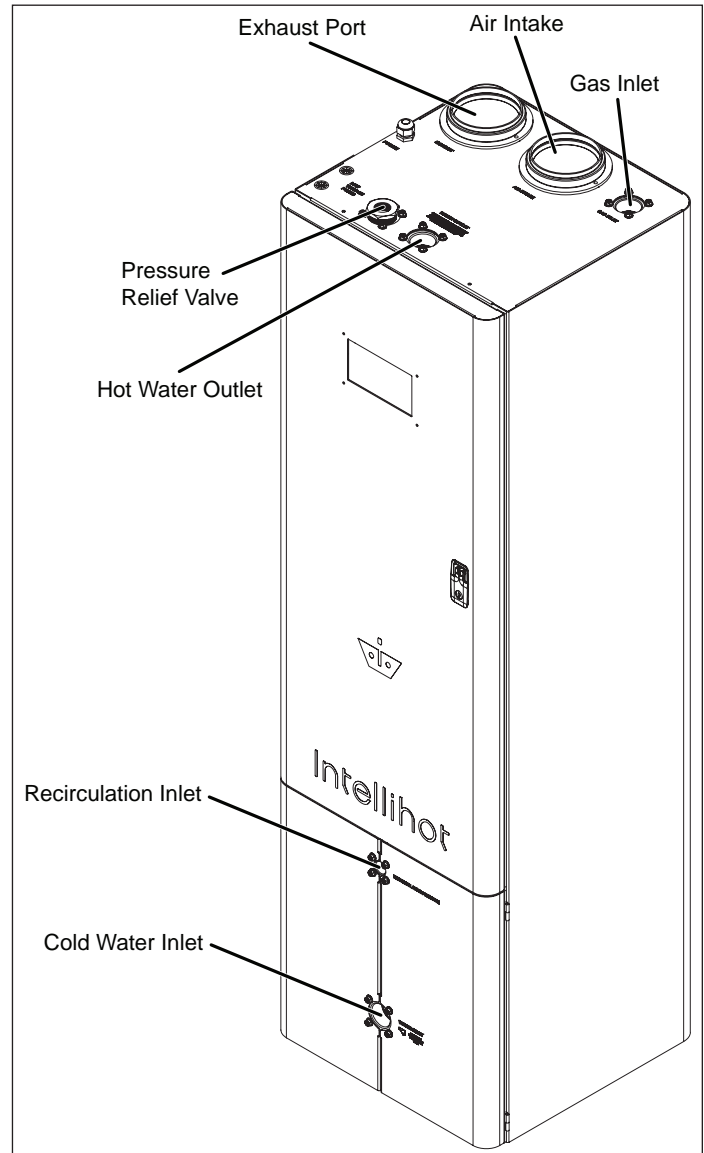

2. Open the gas supply valve, cold water valve, and hot water valve.

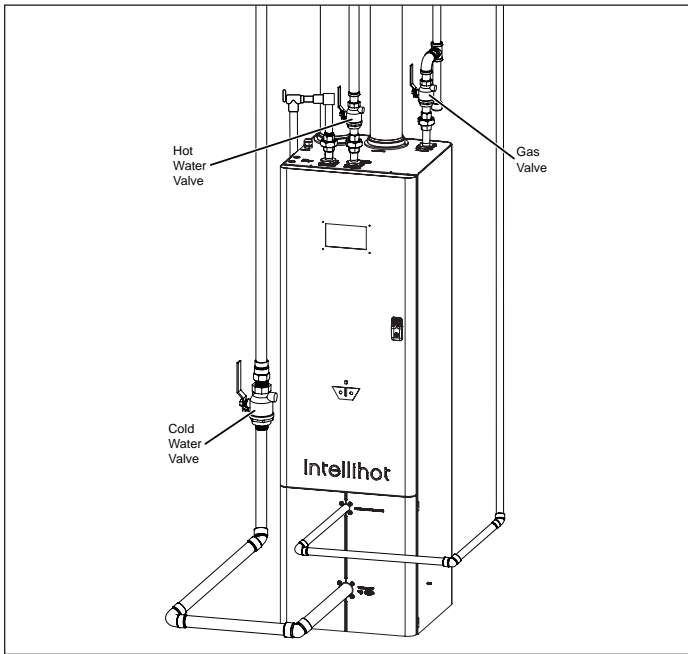

5. Turn ON the power switch at the electrical junction box and turn ON the ON/OFF switch inside the front cabinet door. The water heater's display panel should turn ON.

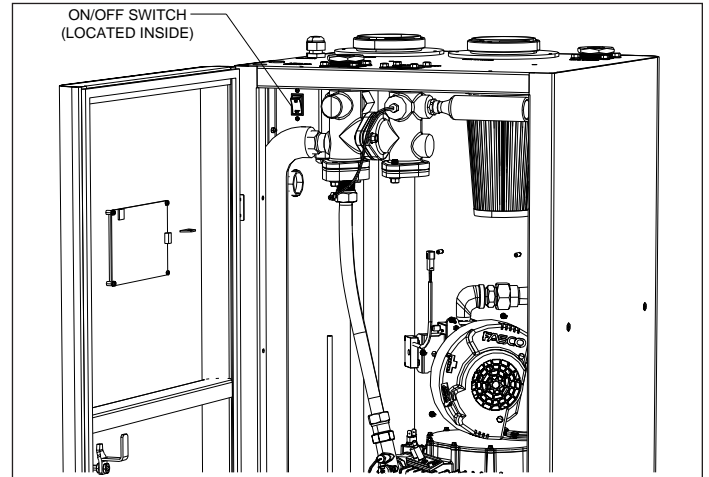

6. Follow the instructions in this manual and on the unit's display screen. For additional information, refer to section "12. Operation" on page 36.

Note: Individual regulators not shown for clarity.

3. With the unit OFF, open a nearby hot water faucet and allow the water to run through the unit until all the air is removed from the water lines and from the water heater.
4. If multiple units are being installed, follow these instructions for each unit.

5. Preparation Before Installation

5.1 Selecting an Indoor Installation Site

NOTE:

- a. When installing the water heater, follow all local building codes and the current edition of the National Fuel Gas Code (ANSI Z223.1/NFPA 54) in the USA, or National Gas and Propane Installation Code (CAN/CGA B149.1) in Canada when installing this product.
 - b. For water heater installations in Massachusetts, refer to section "16. Serviceable Parts" on page 59.
1. Select an interior location for the installation. Each installation is unique; therefore, take the time to find the best location for the water heater.
 - a. Install the water heater near locations that use hot water, such as bathroom, kitchen, or laundry room faucets.
 - b. Select a location that minimizes the length of the water pipe.
 - c. If the distances are long or if the faucet or appliance requires "instant" hot water, we recommend running a recirculation line back to the water heater from the farthest fixture.
 - d. Insulate the hot water supply and recirculation lines.
 - e. Select a location away from foot traffic and away from areas where dust, debris, chemical agents, or other combustible materials could accumulate.
 - f. Allow sufficient space for service and maintenance access to all gas, water, and drain connections.
 - g. Make sure the location meets all building code requirements.
 2. Minimize the distance that the exhaust gas outlet and air intake inlet must travel to an exterior wall.
 - a. The exhaust vent outlet must not be located next to a walkway, near soffit vents, crawl space vents, or other areas where condensate (water vapor) could cause damage or create a hazard. Refer to section "7.7 Venting Clearance Specifications" on page 25 for additional information.
 - b. The fresh air inlet vent must be separated from the exhaust vent per guidelines in section "7. Air Intake Inlet and Exhaust Gas Outlet Pipe Connections" on page 19.
 - c. Contaminated or dirty air drawn into the intake pipe can damage the water heater. The warranty does not cover damage caused by airborne contaminants.

3. Locate the unit close to a drain and near gas and water connections.

The water heater produces a significant amount of condensate during normal operation and should be located near a suitable drain where damage from a possible leak is minimal. Installing the water heater in a location without a drain voids the warranty and the manufacturer is not responsible for any resulting water damages that might occur. For additional information, refer to section "8.4 Condensate Drain Line" on page 29.

4. Locate the water heater and all the water pipes in an area where the ambient temperature always remains above freezing.
 - a. When the water heater is connected to an electrical power supply, it automatically prevents the water from freezing inside the unit.
 - b. The unit's freeze protection system does not prevent the water in the external piping from freezing.

NOTICE

In cold climates, if there is a power failure, the unit's freeze protection system does not operate and can result in water freezing inside the heat engine. To prevent damage to the water heater, turn OFF the gas supply and inlet water valve. Drain the unit completely. Damage caused by freezing water is not covered by the warranty.

5. Select an appropriate location for the combustion air and exhaust pipes to exit the building, as shown in section "7.7 Venting Clearance Specifications".
6. Check the water quality.
 - a. Proper maintenance of the water heater is required to ensure that the water meets EPA quality standards. Refer to section "18. Warranty" on page 68 for quality standard requirements and additional information.
 - b. If you suspect that your water is contaminated in any way, discontinue use of the water heater and contact an authorized technician or licensed professional.
 - c. If the incoming water is known to have a high mineral content or "hardness" (see warranty section), treatment is recommended upstream from the water heater.

6. Gas Connection

WARNING

FIRE AND EXPLOSION HAZARD

To avoid serious injury or even death, the gas line installation and the gas line inlet pressure test must be done by a licensed professional.

Always match the water heater with the type of gas supplied to the unit (natural gas or propane). The water heater is factory preset for natural gas.

Make sure the gas line pressures are within normal limits. Pressures outside normal limits can result in poor performance and hazardous operating conditions.

6.1 Quick Reference Installation Instructions

1. Determine fuel source; natural gas or propane as shown in “6.2 Fuel Source” on page 14.
2. Measure gas pressure as shown in “6.3 Gas Pressure Requirements” on page 14.
3. Install a gas pressure regulator and vent line if gas pressure is above maximum recommendations as shown in “6.4 Gas Pressure Regulator” on page 14.
4. Measure the length of the supply line as shown in “6.5 Length of Gas Supply Line” on page 15.
5. Select the proper gas piping material as shown in “6.6 Gas Piping Material” on page 15.
6. Select the proper gas piping diameter as shown in “6.7 Determine Correct Gas Pipe Diameter” on page 15.
7. Install a drip leg on the gas piping as shown in “6.8 Gas Pipe Drip Leg and Shut-off Valve” on page 15.
8. Install a manual shut-off valve as shown in “6.8 Gas Pipe Drip Leg and Shut-off Valve” on page 15.
9. Test all gas line connections for leaks.

NOTICE

Do not fire (operate) the water heater until all connections have been completed and the heat exchanger is filled with water.

6.2 Fuel Source

1. Natural gas is the factory preset.

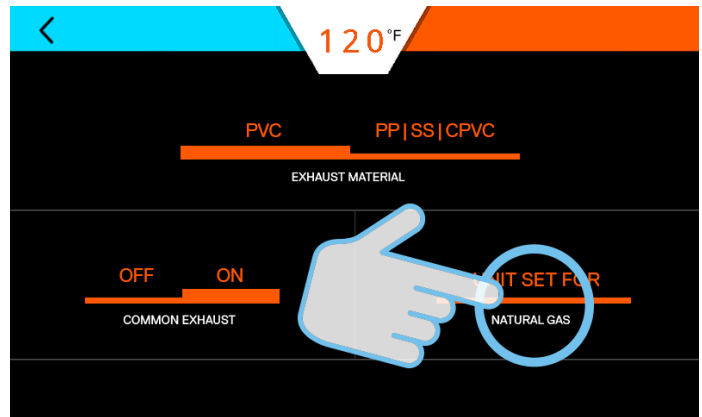

2. To convert the unit to propane, refer to section “11. Natural Gas to Propane Conversion” on page 34.

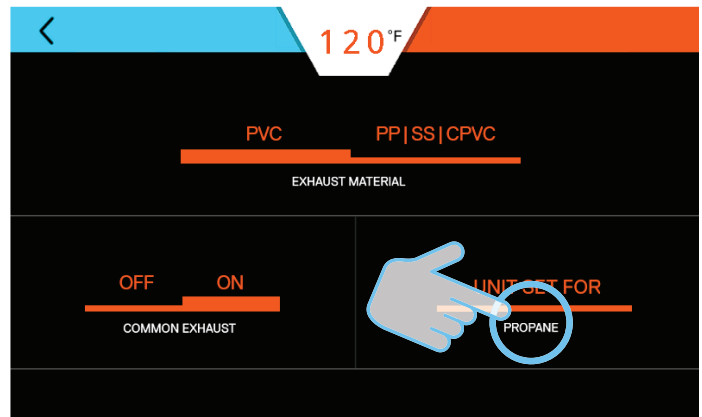

6.3 Gas Pressure Requirements

iN series water heaters are designed to operate at gas pressures as low as 2.5" Water Column (WC) (at maximum firing rate). Gas inlet pressures to each unit should not exceed 14" WC under any condition (whether the unit is firing or not firing).

Natural Gas Static Gas Pressure	
Parameters	Specifications
Minimum Static Gas Pressure	2.5" WC (non-corrugated, black iron)
Recommended Gas Pressure	8" WC
Maximum Static Gas Pressure	14" WC

6.4 Gas Pressure Regulator

1. If the gas inlet pressure is higher than recommended, install a gas pressure regulator to lower gas pressure to an acceptable level.
2. The gas pressure regulator must have the same or higher minimum to maximum modulation range as the iN model it is regulating. For example, an iN199 gas pressure regulator should have a modulation range of 30,000 BTU/h to 199,950 BTU/h.

- When multiple units are connected, use a dedicated gas pressure regulator for each unit.
- Regulators should be mounted with a minimum of 12" of straight length pipe on either side.
- To convert the unit to propane, refer to "11. Natural Gas to Propane Conversion" on page 34.

6.4.1 Venting of Gas Supply Regulators

Make sure the gas supply regulator is properly vented by following all local codes and the gas regulator manufacturer's recommendations.

- The vent pipe must be at least the same size as the regulator vent.
- When multiple units are connected, each regulator must have a separate vent line.
- Vent lines must not be connected together or connected with any other appliance requiring external venting.
- When selecting the size, the pipe diameter must be increased by one size for every 20 feet of pipe.
 - Each 90° elbow is equivalent to approximately:
 - 4.5 feet for nominal pipe sizes of up to 1-1/2"
 - 10.5 feet for nominal pipe sizes of up to 4".
 - Each 45° elbow is equivalent to approximately:
 - 2 feet for nominal pipe sizes of up to 1-1/2"
 - 5 feet for nominal pipe sizes of up to 4".

6.5 Length of Gas Supply Line

- Make sure the length supply line is correctly sized.
 - Measure the length of the gas supply line from the gas meter to the water heater or other appliances requiring gas. The diameter of the pipe must be in relation to the length.
 - The total length of gas piping, as well as fitting pressure drop, must be considered when sizing the gas piping. Total equivalent length should be calculated from the meter or source location to the last heater connected.
 - Gas pipe size should be selected on the total equivalent length. The gas volume for cfh (cubic foot per hour) flow is the input divided by the calorific value of the fuel to be supplied.
 - Use the "6.10 Gas Pipe Sizing Tables" on page 17 or refer to the gas line manufacturers sizing information to determine the correct diameter for the supply pipe.
 - The diameter of the gas lines vary according to the specific installation requirements.

6.6 Gas Piping Material

- All gas piping and components must comply with NFPA local codes, and utility requirements minimum. Only gas approved fittings, valves, or pipe should be utilized.
- Standard industry practice for gas piping is Schedule 40 iron pipe and fittings. All high and low gas pressure piping systems must comply with local utility and building codes.
- Assembled piping should be clean of all scale, debris, metal particles, or foreign material.

- The piping must be supported from the floor, ceiling, or walls and by the water heater itself.

6.7 Determine Correct Gas Pipe Diameter

Note: The water heater should be the first appliance to be connected to the gas supply line.

- Determine the gas requirement of the water heater(s) and other appliances requiring gas.
- Size the pipe diameter according to the COMBINED total maximum BTUH volume for all the appliances as if they were all operating at the same time. Use the "6.10 Gas Pipe Sizing Tables" on page 17.
- Select the proper header pipe according to the number of units being connected together, as shown in the chart.

Header Sizing for Multiple iN Units				
Number of Heaters	1	2	3	4
Sch 40 Iron Pipe	1"	1"	1.5"	1.5"

- The maximum pressure drop from the source to the final water heater must not exceed 0.3" WC.
- The maximum gas flow rate required is the sum of the maximum inputs of each unit divided by the heat of combustion of the fuel supplied at the location (approximately 1,030 BTU per cubic foot for natural gas or 2,520 BTU per cubic foot for propane).

Note: Consult the fuel supplier or utility to confirm that sufficient volume and normal pressure is provided to the building at the discharge side of the gas meter or supply pipe.

6.8 Gas Pipe Drip Leg and Shut-off Valve

- Install a gas pipe drip leg on each water heater to prevent dirt, condensation, or debris from entering the gas inlet.

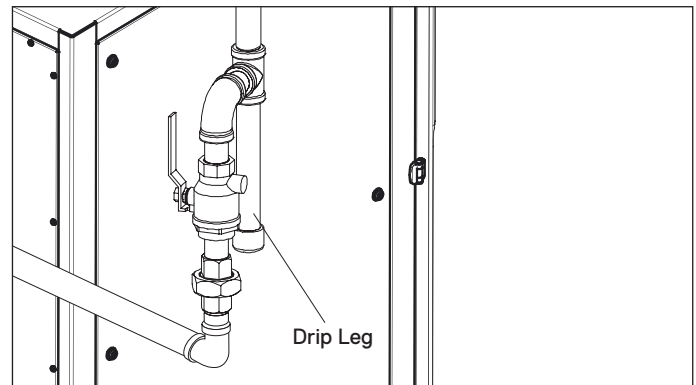

- Local codes might require multiple units to have a full size drip leg on the main gas supply line and one on each unit.
- The drip leg should have a removable clean-out cap.
- The gas pipe must not be supported by the drip leg.
- Follow local building codes when selecting and installing a shut-off valve.
- Local codes might require multiple units to have a shut-off valve on the main gas supply line and one on each unit.

6.9 Connecting Gas Line to Unit

Note: Always clean the inside of the gas line of any dirt or debris before connecting the piping to the unit.

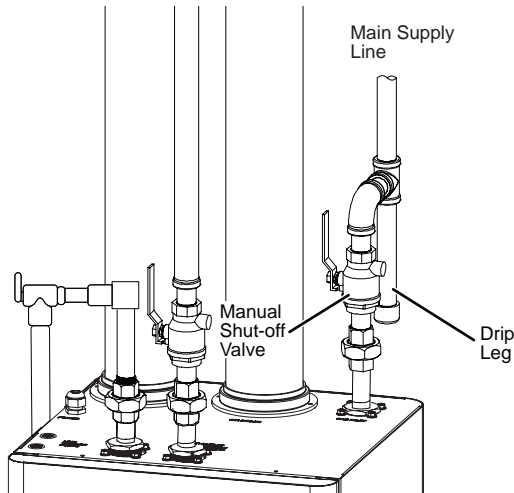

Note: Individual gas regulators not shown for clarity.

2. Install a manual shut-off valve as described in “6.8 Gas Pipe Drip Leg and Shut-off Valve” on page 15.

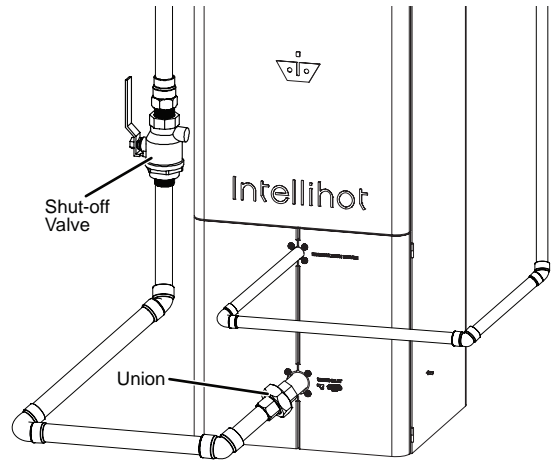

Note: Wye-Strainer not shown for clarity.

3. Install a drip leg as described in “6.8 Gas Pipe Drip Leg and Shut-off Valve” on page 15.
4. Continue installing pipe to reach the main gas supply connection.
5. Test all gas pipe connections.
 - a. All the gas pipe connections should be tested as prescribed in NFPA 54.
 - b. In multiple unit applications, each unit should be isolated before testing any piping system as pressure might exceed the allowable pressure of 14.0” WC.

NOTICE

Do not fire (operate) the water heater until all connections have been completed and the heat exchanger is filled with water.

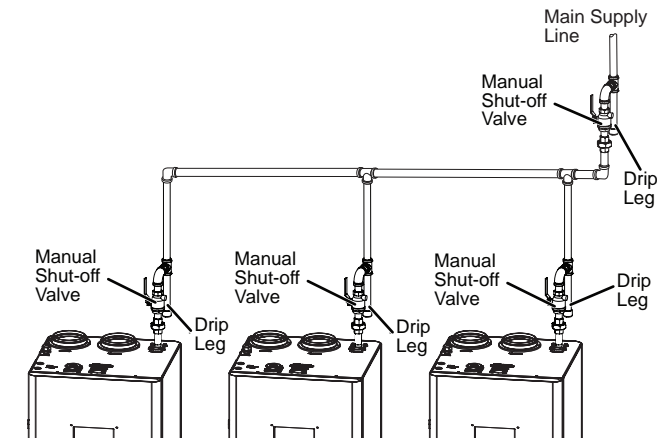

Note: Individual gas regulators not shown for clarity.

1. Install a flanged steel coupling and gasket with a short piece of 3/4" NPT black pipe.

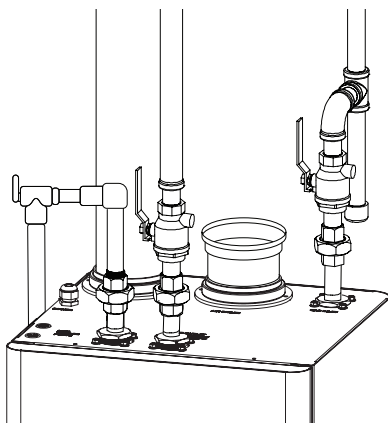

Note: Individual gas regulators not shown for clarity.

6.10 Gas Pipe Sizing Tables

This information is for reference only. Refer to gas pipe manufacturer specifications for actual delivery capacity. Contact the local gas supplier for actual BTU/ft³ rating. This data is copied from the National Fire Protection Association Article 54 (NFPA 54).

Pipe Sizes and BTU/h Capacity (NATURAL GAS). Use this table for static gas pressure LESS THAN 5" WC								
Length including fittings (feet)	3/4"	1"	1-1/4"	1-1/2"	2"	2-1/2"	3"	4"
10	360,000	678,000	1,390,000	2,090,000	4,020,000	6,400,000	11,300,000	23,100,000
20	247,000	466,000	957,000	1,430,000	2,760,000	4,400,000	7,780,000	15,900,000
30	199,000	374,000	768,000	1,150,000	2,220,000	3,530,000	6,250,000	12,700,000
40	-	320,000	657,000	985,000	1,900,000	3,020,000	5,350,000	10,900,000
50	-	284,000	583,000	873,000	1,680,000	2,680,000	4,740,000	9,660,000
60	-	257,000	528,000	791,000	1,520,000	2,430,000	4,290,000	8,760,000
70	-	237,000	486,000	728,000	1,400,000	2,230,000	3,950,000	8,050,000
80	-	220,000	452,000	677,000	1,300,000	2,080,000	3,670,000	7,490,000
90	-	207,000	424,000	635,000	1,220,000	1,950,000	3,450,000	7,030,000
100	-	-	400,000	600,000	1,160,000	1,840,000	3,260,000	6,640,000
125	-	-	355,000	532,000	1,020,000	1,630,000	2,890,000	5,890,000
150	-	-	322,000	482,000	928,000	1,480,000	2,610,000	5,330,000
175	-	-	296,000	443,000	854,000	1,360,000	2,410,000	4,910,000
200	-	-	275,000	412,000	794,000	1,270,000	2,240,000	4,560,000

Note: BTU/h capacities are based on specific gravity of 0.6, pressure drop of 0.5" WC.

Pipe Sizes and BTU/h Capacity (NATURAL GAS). Use this table for static gas pressure GREATER THAN 5" WC									
Length including fittings (feet)	1/2"	3/4"	1"	1-1/4"	1-1/2"	2"	2-1/2"	3"	4"
10	404,000	949,000	1,787,000	3,669,000	5,497,000	10,588,000	16,875,000	29,832,000	43,678,000
20	286,000	652,000	1,228,000	2,522,000	3,778,000	7,277,000	11,598,000	20,503,000	30,020,000
30	233,000	524,000	986,000	2,025,000	3,034,000	5,844,000	9,314,000	16,465,000	24,107,000
40	202,000	448,000	844,000	1,733,000	2,597,000	5,001,000	7,971,000	14,092,000	20,632,000
50	-	397,000	748,000	1,536,000	2,302,000	4,433,000	7,065,000	12,489,000	18,286,000
60	-	360,000	678,000	1,392,000	2,085,000	4,016,000	6,401,000	11,316,000	16,569,000
70	-	331,000	624,000	1,280,000	1,919,000	3,695,000	5,889,000	10,411,000	15,243,000
80	-	308,000	580,000	1,191,000	1,785,000	3,437,000	5,479,000	9,685,000	14,181,000
90	-	289,000	544,000	1,118,000	1,675,000	3,225,000	5,140,000	9,087,000	13,305,000
100	-	273,000	514,000	1,056,000	1,582,000	3,046,000	4,856,000	8,584,000	12,568,000
125	-	242,000	456,000	936,000	1,402,000	2,700,000	4,303,000	7,608,000	11,139,000
150	-	219,000	413,000	848,000	1,270,000	2,446,000	3,899,000	6,893,000	10,093,000
175	-	202,000	380,000	780,000	1,169,000	2,251,000	3,587,000	6,342,000	9,285,000
200	-	-	353,000	726,000	1,087,000	2,094,000	3,337,000	5,900,000	8,638,000

Note: For 1/2" line, BTU/h capacities are based on specific gravity of 0.6, pressure drop of 4.6" WC and 5.0" WC. For all other line sizes, capacities are based on specific gravity of 0.6, pressure drop of 3.0" WC.

**Pipe sizes and BTU/h capacity (PROPANE). Use this table for static gas pressure
GREATER THAN 5" WC.**

Length including fittings (feet)	1/2"	3/4"	1"	1-1/4"	1-1/2"	2"	2-1/2"	3"	4"
10	409,000	608,000	1,150,000	2,350,000	3,520,000	6,790,000	10,800,000	19,100,000	39,000,000
20	289,000	418,000	787,000	1,620,000	2,420,000	4,660,000	7,430,000	13,100,000	26,800,000
30	236,000	336,000	632,000	1,300,000	1,940,000	3,750,000	5,970,000	10,600,000	21,500,000
40	204,000	287,000	541,000	1,110,000	1,660,000	3,210,000	5,110,000	9,030,000	18,400,000
50	-	255,000	480,000	985,000	1,480,000	2,840,000	4,530,000	8,000,000	16,300,000
60	-	231,000	434,000	892,000	1,340,000	2,570,000	4,100,000	7,250,000	14,800,000
80	-	212,000	400,000	821,000	1,230,000	2,370,000	3,770,000	6,670,000	13,600,000
100	-	-	372,000	763,000	1,140,000	2,200,000	3,510,000	6,210,000	12,700,000
125	-	-	349,000	716,000	1,070,000	2,070,000	3,290,000	5,820,000	11,900,000
150	-	-	330,000	677,000	1,010,000	1,950,000	3,110,000	5,500,000	11,200,000
175	-	-	292,000	600,000	899,000	1,730,000	2,760,000	4,880,000	9,950,000
200	-	-	265,000	543,000	814,000	1,570,000	2,500,000	4,420,000	9,010,000

Note: The line BTU/h capacities are based on specific gravity of 1.5, pressure drop of 0.5" WC.

7. Air Intake Inlet and Exhaust Gas Outlet Pipe Connections

DANGER

Improper venting of the water heater results in excessive levels of carbon monoxide, which can lead to severe personal injury or death. This water heater must be vented in accordance with the “Venting of Equipment” section of the latest edition of the ANSI Z223.1 / NFPA 54 (Natural Fuel Gas Code) in the USA, or in Canada refer to the “Venting Systems and Air Supply for Appliances” section in the latest version of CAN/CGA B149.1 (Natural Gas and Propane Installation Code), and all applicable local building codes. Vent installation should be performed only by a licensed professional.

 **WARNING**

 **BREATHING HAZARD
CARBON MONOXIDE GAS**

- Do not operate flood-damaged water heaters.
- Install venting system according to the required codes and material manufacturers specifications.
- Do not obstruct fresh air intakes or exhaust outlets. Adequately support all vent system piping.
- Do not place vapor-emitting products near water heater or air intake.
- Place working carbon monoxide detectors outside each sleeping area.
- Do not operate the water heater before properly installing the exhaust outlet.
- Inspect the vent system and eliminate any possible area where condensation could create a blockage of intake or exhaust air.

Breathing concentrated levels of carbon monoxide, even for a short period, causes brain damage and can even lead to death.

Note: This water heater falls into the Category IV appliance.

7.1 Quick Reference Installation Guide

1. Select the desired type of venting system: Two Pipe Vent System (Direct) or Single Pipe Vent System (Power).
 - “7.3 Two Pipe Vent System (Direct Vent)” on page 20.
 - “7.4 Single Pipe Venting System” on page 22.
2. Select the desired termination of the air intake inlet and exhaust gas outlet pipe: outside wall or roof.
 - “7.3.3 Side Wall Air Intake Inlet and Exhaust Gas Outlet Pipe Termination” on page 21.
 - “7.3.4 Roof Air Intake Inlet and Exhaust Gas Outlet Pipe Termination” on page 22.

3. Determine the straight line distance and the number of elbows required to route the air intake inlet and exhaust gas outlet pipes to their termination point. See “7.6 Intake Air Inlet and Exhaust Gas Outlet Pipe Diameter and Length” on page 24.
4. Determine the diameter of pipe required to properly bring in intake air and vent exhaust gas. See “7.6 Intake Air Inlet and Exhaust Gas Outlet Pipe Diameter and Length” on page 24.
5. Verify that the location of the air intake inlet and exhaust gas outlet terminations are within state and local codes. See “7.7 Venting Clearance Specifications” on page 25.
6. Select an approved material for the air intake inlet piping. See “7.8 Exhaust Gas Outlet Pipe Materials” on page 26.
7. Select an approved material for the exhaust gas outlet piping. See “7.9 Air Intake Inlet Pipe Vent Materials” on page 26.

7.2 Typical Single Unit Air Intake Inlet and Exhaust Gas Outlet Pipe Installation

1. Select one of the following two venting configurations:
 - Two pipes (direct vent) configuration
 - One pipe (power vent) configuration
2. Select the desired termination location and make sure each pipe terminates according to all local and state codes.
3. Select the desired material for the air intake inlet and exhaust gas outlet pipes.

CAUTION

This water heater has a factory preset control to limit the exhaust gas temperature to 149°F (65°C) when the PVC is selected in the “Flue Type” programming section. As a result, the water heater can be vented with Schedule 40 PVC. If the incoming (or recirculation return) water temperature does not exceed 150°F (66°C), the exhaust gas temperature does not exceed 149°F (65°C).

WARNING

When the unit is set for CPVC (polypropylene pipe), flue temperatures can reach 190°F (88°C). PVC pipe melts at temperatures above 149°F (65°C) and could therefore result in a fire. Make sure the setting and the type of material being used for the flue are compatible.

For this application, use Schedule 80 CPVC or Approved Polypropylene in the USA or Type BH Special Gas Vent Class IIB (CPCV) or Class IC (Polypropylene) that conforms to ULC-S636 in Canada.

**SAFETY
INSTRUCTIONS**

On multiple unit installations, the air intake inlet and exhaust gas outlet piping from each water heater must be connected into the properly-sized common piping. Use the table in “7.6 Intake Air Inlet and Exhaust Gas Outlet Pipe Diameter and Length” on page 24 to determine the diameter of the common connecting piping between each individual water heater.

4. Determine the length and corresponding diameter for the air inlet pipe and route the pipe to the desired termination location.
 - a. For termination of the pipe to the outside, continue installing the required pipe to a suitable outside location. Glue all connections, making sure the joints are sealed airtight.
 - b. Install suitable pipe support hangers every 4 to 5 feet, or as local building codes require.

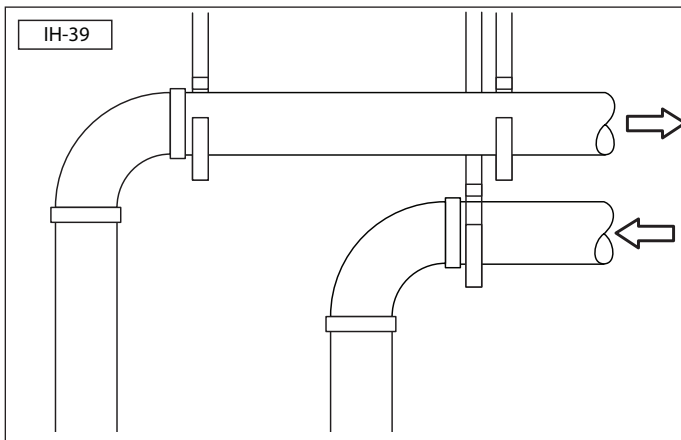

- c. To configure the unit for power vent, insert a 3' section of 3" pipe.
5. Determine the length and corresponding diameter for the exhaust gas outlet pipe and route it to a suitable outside location.
 - a. Glue all connections, making sure the joints are sealed airtight.
 - b. Install all horizontal exhaust gas outlet piping with a minimum 2 degree (1/4" per foot) slope back toward the water heater. This allows any condensate that accumulates in the exhaust gas outlet pipe to properly drain back into the unit.
 - c. Install suitable pipe support hangers every 4 to 5 feet, or as local building codes require.

**SAFETY
INSTRUCTIONS**

Do not connect any other appliance vents to the water heater inlet or outlet pipes.

6. If multiple units are installed, make sure the diameter of the connecting exhaust gas outlet pipe is properly sized for the number of units being installed.

7.3 Two Pipe Vent System (Direct Vent)

7.3.1 Single Unit Configurations

The water heater can be directly vented without any modification using a 3-inch diameter pipe.

The following diagrams represent some typical direct venting configurations and are included to assist in designing the vent system. Possible configurations are not limited to the following diagrams.

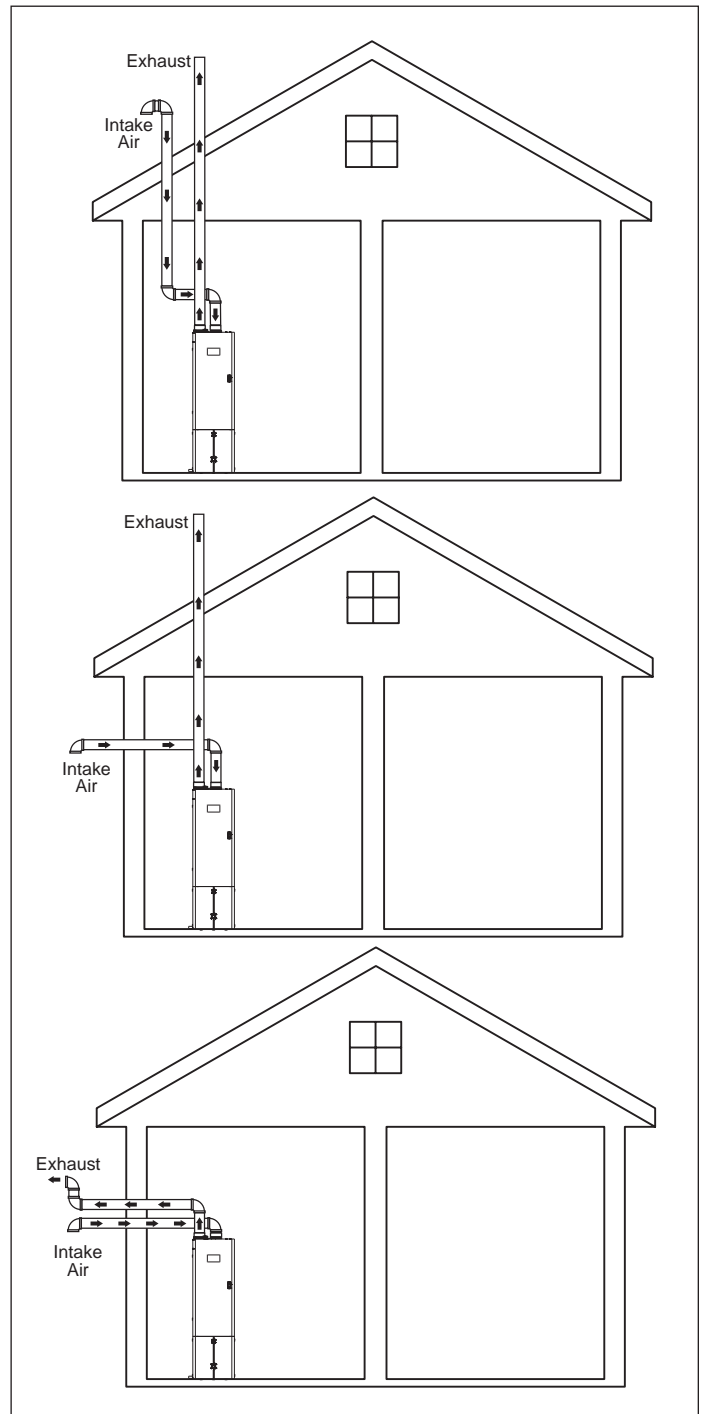

7.3.2 Multiple Units Configurations

When more than one unit is installed, refer to “7.6 Intake Air Inlet and Exhaust Gas Outlet Pipe Diameter and Length” on page 24.

Connecting multiple units together requires proper sizing of the air intake inlet and exhaust gas outlet pipes. Up to four water heaters can be cascaded together. Units which share a common vent must be connected together in a cascading configuration, as described in “13. Connecting Multiple Units” on page 47.

The following diagrams represent some typical direct venting configurations and are included to assist in designing the vent system. Possible configurations are not limited to the following diagrams.

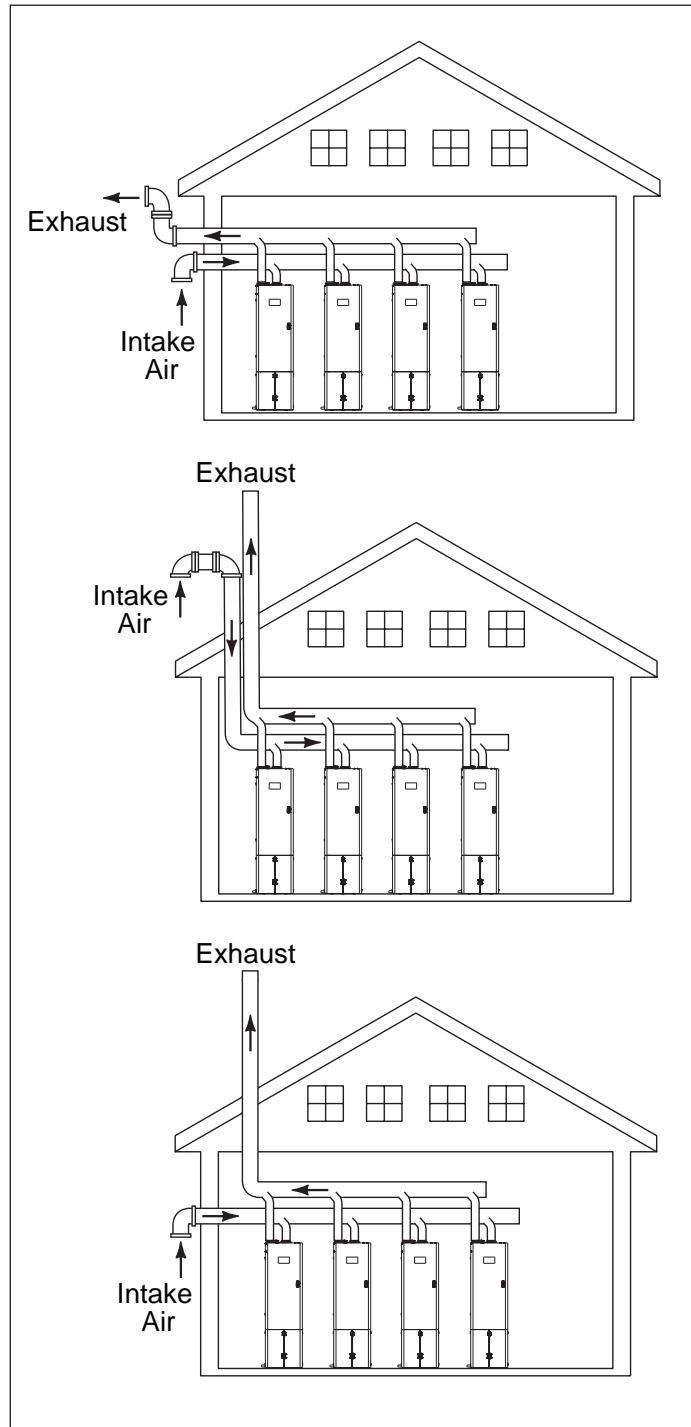

7.3.3 Side Wall Air Intake Inlet and Exhaust Gas Outlet Pipe Termination

1. Terminate the air intake inlet pipe with a 90° elbow (angled down). Use a flange and PVC screen (not supplied).
2. Terminate the exhaust gas outlet pipe on the exterior wall at least 12" above ground and at least 18" away from the air intake inlet pipe, or as required by local building codes. In areas of high snow fall, protect the vent terminations from blockage. Use a flange and PVC guard.

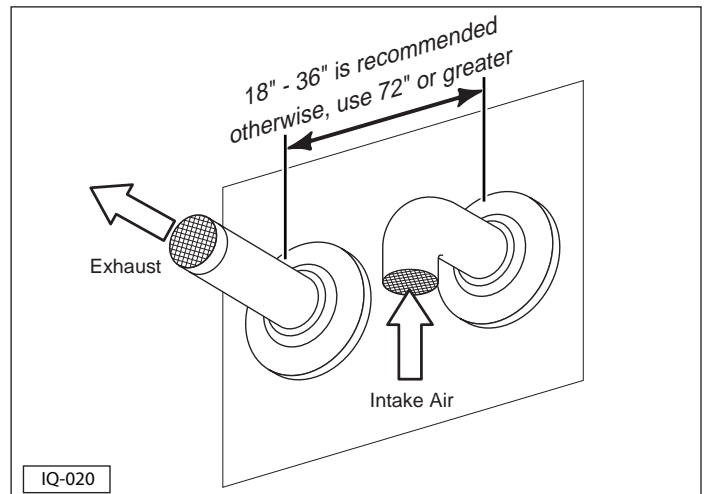

Single unit.

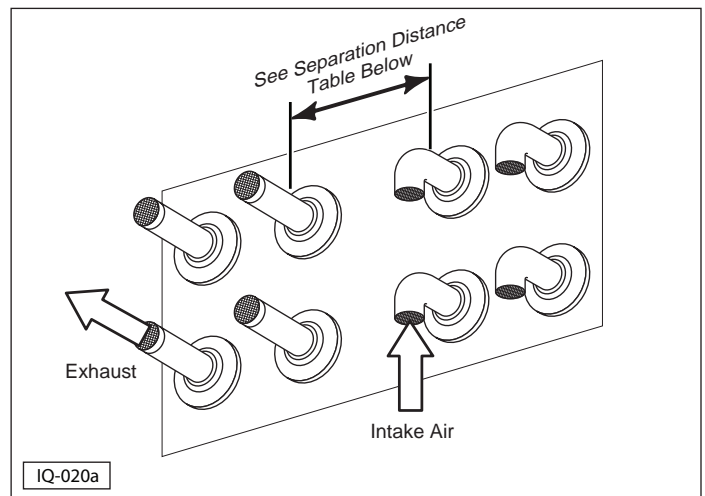

Multiple units.

Separation Distance	Status
0 - 17.9"	Not Allowed
18" - 36"	Allowed
36.1" - 71.9"	Not Allowed
72" or greater	Allowed

3. To avoid moisture and frost build-up to openings on adjacent structures, use 45° elbows, 90° elbows, or tees for the vent termination to direct the exhaust gas fumes away from the building.

7.3.4 Roof Air Intake Inlet and Exhaust Gas Outlet Pipe Termination

With this installation method, the terminations must extend at least 12 inches over maximum potential snow levels, or as required by local building codes. In areas of high snow fall, protect the vent terminations from blockage.

Terminate the air intake inlet pipe with a 90° elbow (angled down). A suitable roof flashing and vent cap (not supplied) should be installed.

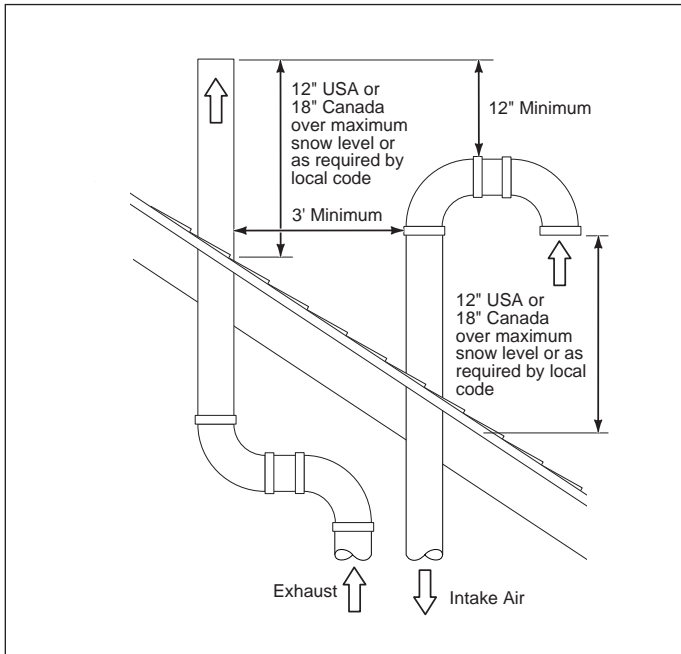

Single unit.

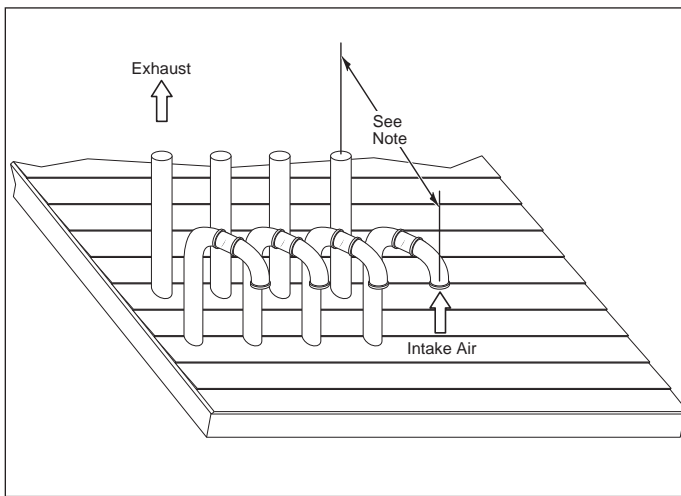

Multiple units.

Note: The distance between any exhaust gas outlet and air intake inlet pipe should be between 18 and 36 inches apart. If this minimum specification cannot be met, the air intake inlet and exhaust gas outlet pipes should be 72 inches apart or more.

7.4 Single Pipe Venting System

7.4.1 Single Unit

The following illustrations represent some typical venting configurations and are included to assist in designing the vent system. Possible configurations are not limited to these designs.

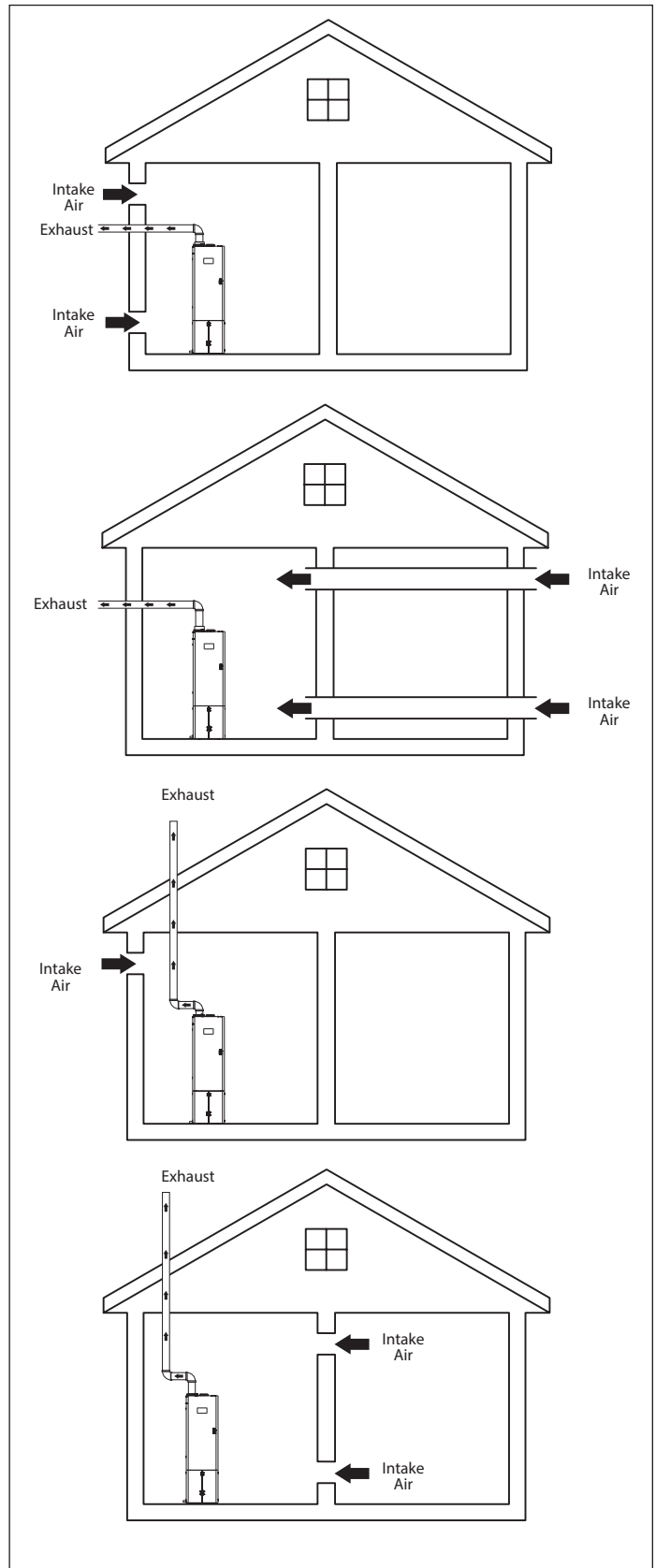

7.4.2 Multiple Units

When installing multiple units, refer to “7.6 Intake Air Inlet and Exhaust Gas Outlet Pipe Diameter and Length” on page 24.

Connecting multiple units together requires proper sizing of the air intake inlet and exhaust gas outlet pipes. Up to four water heaters can be cascaded together. Units which share a common vent must be connected together in a cascading configuration, as described in “13. Connecting Multiple Units” on page 47

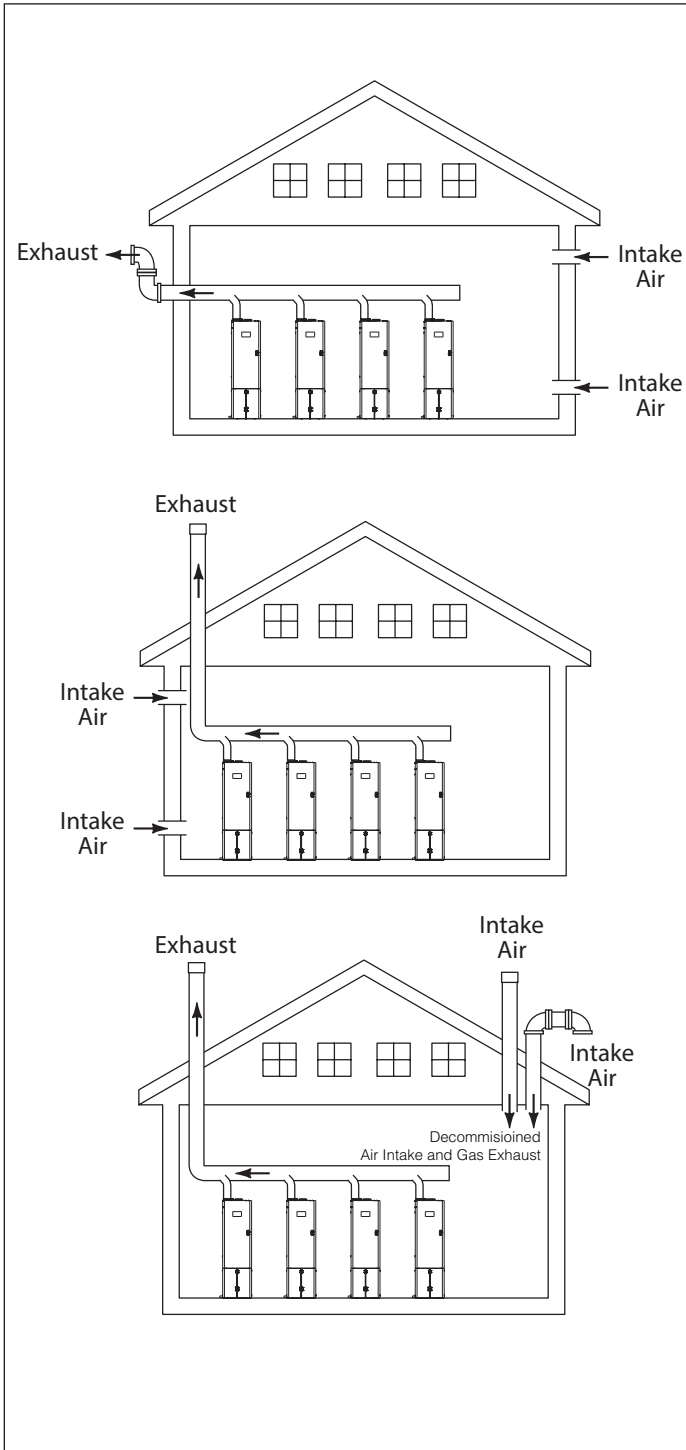

7.5 Combustion Air Requirements

When using the single exhaust gas outlet pipe or vent method, the following table outlines the required opening sizes for the combustion and ventilation air coming into the room and the required CFM requirements per water heater:

SAFETY INSTRUCTIONS

Do not operate the unit in an area that draws in outside air contaminated with high levels of dust, sawdust, aerosols such as paint, or other airborne contaminants.

If necessary, purchase and install appropriate air screens and follow a regular cleaning program to ensure an adequate supply of clean, outside combustion air.

Required Combustion & Ventilation Air Opening Sizes (sq. in.) Per Heater Per Boiler Room:							
Model	Input	Air Type	Required CFM	Air is drawn directly from outside into the mechanical room			Air is drawn from another interior space inside the building
				Through two openings*, direct or vertical	Through one opening**	Through two horizontal ducts	
iN199	199,950	Combustion Air	36	50	63	100	200
		Ventilation Air	36	50		100	200

*Where two openings are used, one must be within 12 inches of the floor and the other opening must be within 12 inches of the ceiling of the mechanical room.
 **Where one opening is required, it must be located within 12 inches of the ceiling.

7.6 Intake Air Inlet and Exhaust Gas Outlet Pipe Diameter and Length

The iN199 comes factory installed with 3-inch polypropylene (PP) venting. The following chart outlines the maximum length of venting allowable for each model.

A vent system's length is calculated by adding the length of all straight runs used (both horizontal and vertical) and then adding the equivalent lengths of each turn (90° or 45° elbow) used in the system.

SAFETY INSTRUCTIONS

A vent system's length must not exceed the maximum length outlined in the chart below.

Maximum Pipe Length in Feet				
Number of Units	Venting Type	Diameter, Model, and Length in Feet		
		3" Diameter	4" Diameter	6" Diameter
		iN199	iN199	iN199
1	1 pipe	195	250	250
	2 pipe	95	125	125
2	1 pipe	55	228	250
	2 pipe	28	114	125
3	1 pipe		110	250
	2 pipe		55	125
4	1 pipe			250
	2 pipe			125

Note:

- 1 Pipe - Only exhaust-out pipe is connected and the combustion air intake is from within the room. For example, one iN199 with a 3" diameter, the maximum exhaust pipe length for 1 pipe is 195 feet.
- 2 Pipe - Both the combustion air intake and the exhaust pipe are connected. In this case, the table specifies the maximum length per pipe. For example, one iN199 with 3" diameter, 95 feet maximum is allowed for combustion air intake pipe and exhaust-out pipe. The 95 feet maximum is per pipe.
- Reduce the maximum equivalent length above by 5 feet per 90° elbow used and by 2 feet per 45° elbow used. Do not exceed the above set limits.
- If Multiple units are common-vented, then the units must be cascaded. Refer to section "7.5 Combustion Air Requirements" on this page for how to do combustion with common-vented units.

7.7 Venting Clearance Specifications

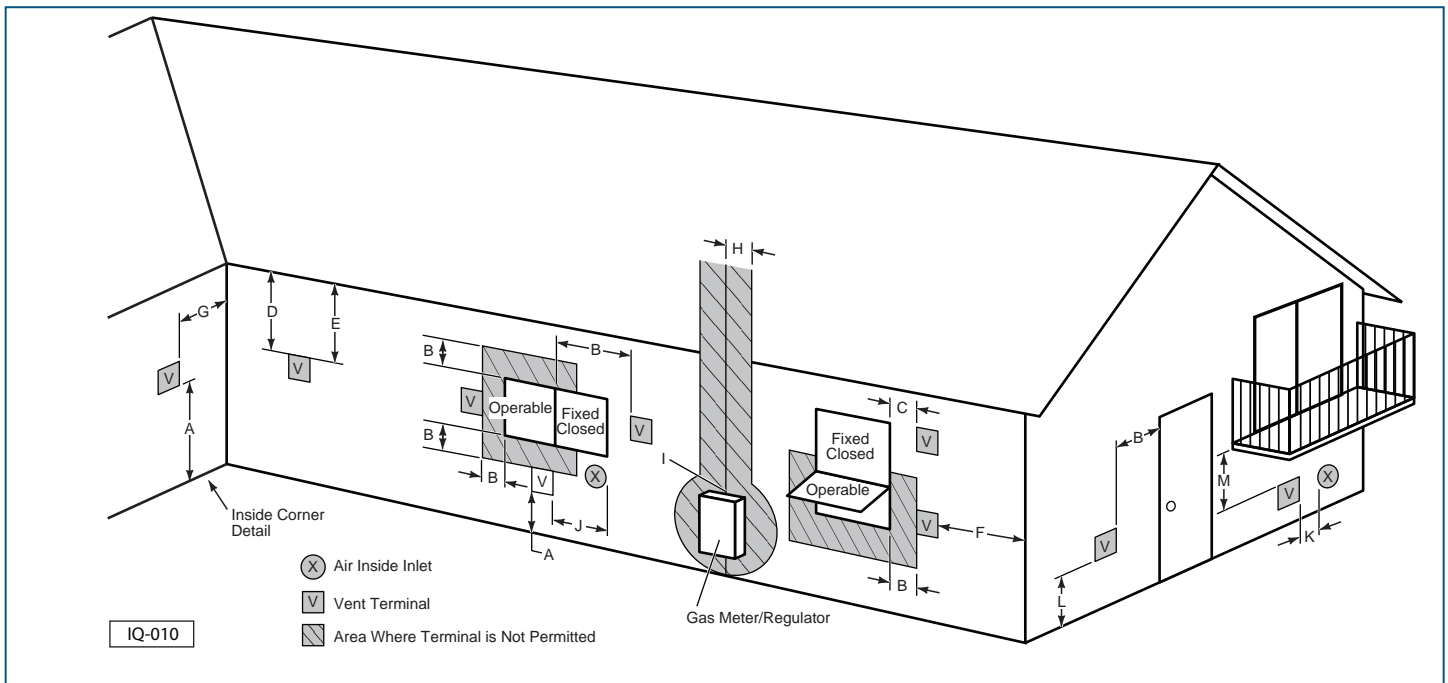

Venting Clearance Specifications			
Item	Description	Clearance Distance	
		USA ¹	Canada ²
A	Clearances above grade, veranda, porch, deck, or balcony	1 foot	1 foot
B	Clearances to window or door that can be opened	1 foot**	3 feet
C	Clearances to permanently closed window	*	*
D	Vertical clearance to a ventilated soffit, eaves, or overhang	*	*
E	Clearances to unventilated soffit, eaves, or overhang	*	*
F	Clearances to outside corner	*	*
G	Clearances to inside corner	*	*
H	Clearances to each side of centerline extended from meter/regulator	*	3 feet within a height 15 feet above meter/regulator assembly
I	Clearances to gas meter regulator vent outlet	*	3 feet
J	Clearances to non-mechanical air supply inlet or combustion air inlet to any other appliance	1 foot**	3 feet
K	Clearances to mechanical air supply inlet	3 feet above if within 10 feet horizontally	6 feet
L	Clearances above paved sidewalk or paved driveway on public property	*	7 feet
M	Clearances under veranda, porch, deck, or balcony	*	1 foot

*Per local/gas supplier codes. Use clearances in accordance with local building codes and local gas supplier.
 ** For single vent pipe/direct 4 feet (1.2 m) below or to the side of opening and 1 foot above opening.
¹ In accordance with Z223.1
² In accordance with CSA B149.1

Note:

The vent for this appliance shall not terminate:

- Over public walkways
- Near soffit vents or crawl space vents or other areas where condensate or vapor could create a nuisance or hazard or cause property damage
- Where condensate vapor could cause damage or could be detrimental to the operation of regulators, relief valves, or other equipment

7.8 Exhaust Gas Outlet Pipe Materials

SAFETY INSTRUCTIONS

For Canadian installations, plastic exhaust gas outlet piping must comply with CAN/CGA B149.1 and be certified to the Standard For Type BH Gas Venting Systems, ULC-S636. Components of this listed system must not be interchanged with other vent systems or unlisted pipes or fittings. All plastic components and specified primers and glues must be from a single system manufacturer and must not be intermixed with another system manufacturer's products.

All units come factory installed with 3-inch polypropylene (PP) venting. A polypropylene-to-PVC adapter is included with each unit to enable the use of PVC exhaust gas outlet pipe. The maximum allowable venting distances are the same regardless of vent material selected.

The materials listed in the tables below outline the acceptable exhaust gas outlet pipe materials:

United States Exhaust Gas Outlet Pipe Standards	
Material	Description*
Exhaust Gas Outlet Pipe	PVC Schedule 40 (ASTM D1785)
	CPVC Schedule 80
	Approved Polypropylene
	AL29-4C Stainless Steel

Canadian Exhaust Gas Outlet Pipe Standards	
Material	Description (approved to ULC-S636)**
Exhaust Gas Outlet Pipe	Type BH Special Gas Vent Class IIA (PVC)
	Type BH Special Gas Vent Class IIB (CPVC)
	Type BH Special Gas Vent Class IIC (Polypropylene)
	Type BH Special Gas Vent Class I (AL29-4C Stainless Steel)

*Note: Use of cellular core PVC (ASTM F891), cellular core CPVC, or Radel (polyphenylsulfone) in nonmetallic venting systems is prohibited. Covering nonmetallic vent pipe and fittings with thermal insulation is prohibited.

**Note: The components (pipe, fittings, primers, and glues) must be from a single manufacturer; do not interchange. Follow the vent manufacturer's certified instructions.

SAFETY INSTRUCTIONS

Do not use cellular foam core pipe to vent exhaust gases.

This water heater has a built-in exhaust gas outlet temperature control that limits the exhaust gas temperature to a maximum of 149°F (65°C) for PVC pipe. In commercial applications which require higher water temperatures, exhaust gas temperature can reach 190°F (88°C) and require materials such as polypropylene (PP), stainless steel (SS), or CPVC.

If the temperature approaches the upper limit, the burner turns off automatically to protect the vent pipe. After the exhaust gas temperature has dropped to a normal operating level, the unit automatically restarts.

If the inlet/return water temperature exceeds 150°F (66°C), do not use PVC pipe. Follow the display prompts to set the maximum water temperature for the exhaust-gas outlet pipe material being used.

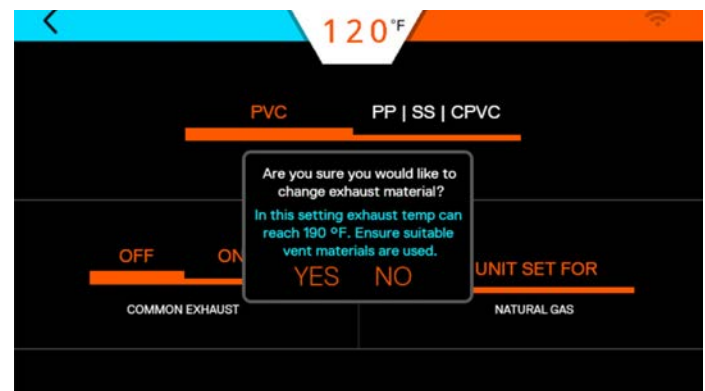
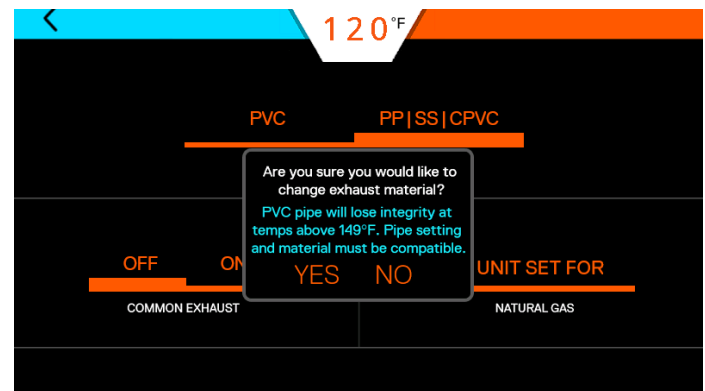

7.9 Air Intake Inlet Pipe Vent Materials

The air intake inlet pipe can be of any plastic or metal vent material available. ABS, PVC, polypropylene, galvanized steel, and/or flexible corrugated ducting are all examples. When using a corrugated material, ensure there is no inadvertent crimping or blockage to the air intake inlet pipe.

Refer to the tables below for a list of approved materials.

United States Vent Pipe Standards	
Material	Description
Vent Pipe	PVC Schedule 40
	CPVC Schedule 80
	Approved Polypropylene

Canadian Vent Pipe Standards	
Material	Description
Vent Pipe	Type BH Special Gas Vent Class IIA (PVC)
	Type BH Special Gas Vent Class IIB (CPVC)
	Type BH Special Gas Vent Class IIC (Polypropylene)

Note: In addition to these charts, it is recommended to consult the most recent edition of ANSI Z223.1/NFPA 54 or CAN/CGA B149.1, as well as all applicable local codes and regulations when selecting vent pipe materials.

7.10 Recommended Exhaust-Gas Outlet Pipe Transitions

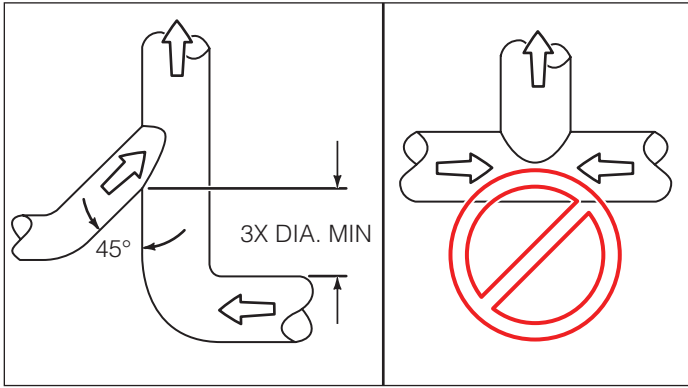

Do not direct exhaust gas from opposite directions. Use a 45 degree transition, as shown.

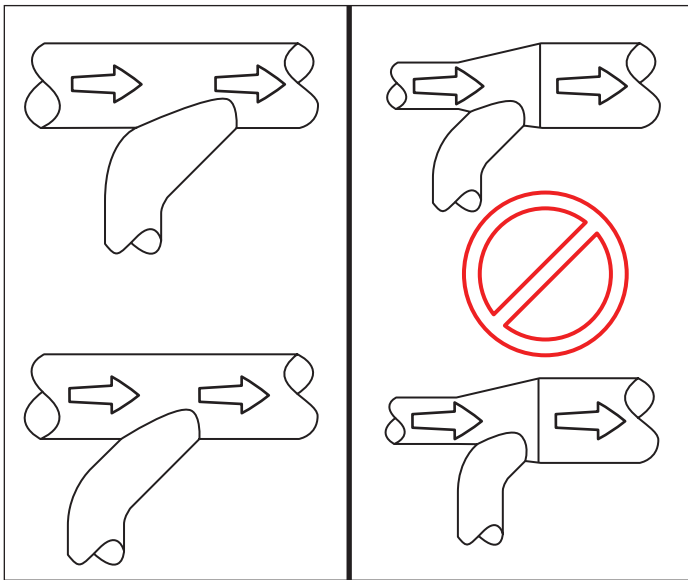

Do not transition into a reducer or use a t-fitting. Transitions should always be directed into a straight run of pipe.

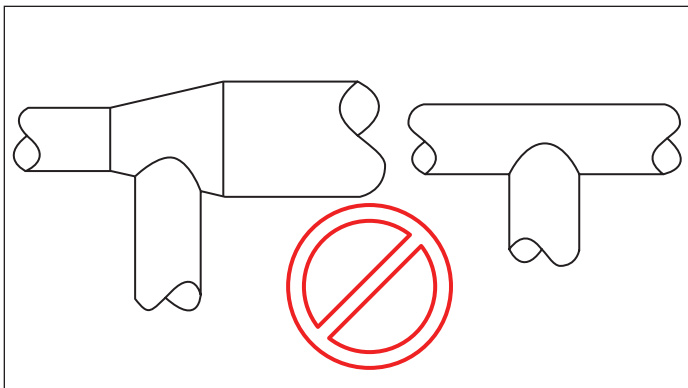

Do not use 90 degree transition into a reducer or a straight pipe.

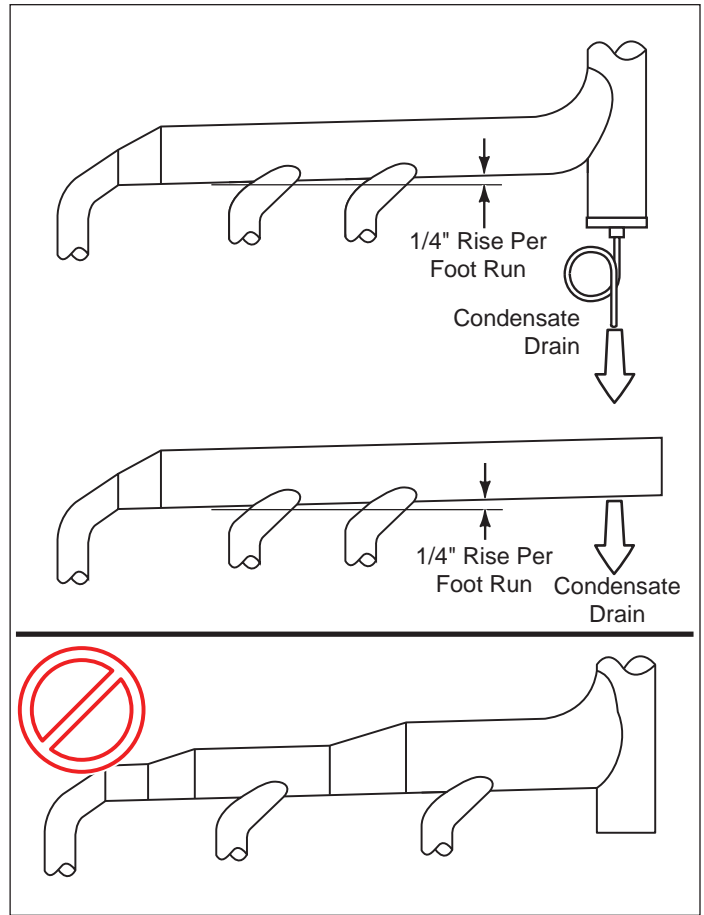

Do not use reducers in a straight run of pipe.

8. Water Connections

Note: For flow rate changes faster than 10 gpm (gallons per minute) in one second, a water hammer arrester must be installed to prevent damage to the water heater.

8.1 Quick Reference Installation Instructions

1. Install the hot water pipe and the pressure relief valve (furnished with the water heater) as per “8.2 Hot Water Connection” on page 28.

NOTICE

When tightening any fittings to the connections on the water heater, do not overtighten these joints and damage the unit.

2. Install the cold water pipe as per “8.3 Cold Water Connection” on page 29.
3. Install a condensate drain line as per “8.4 Condensate Drain Line” on page 29.
4. After installation is complete, fill and test the water heater for proper flow and inspect for leaks.
5. Run the hot water for a few minutes and then clean the inlet water strainer located on the cold water inlet fitting. This strainer must be cleaned periodically to maintain proper water flow.

8.2 Hot Water Connection

Install and connect the hot water lines. Keep the hot water pipes as short as possible to deliver hot water to the fixtures quickly. If an optional hot water storage tank is required, connect the hot water lines to this tank also.

Since each installation is different, it is up to the installer to route the water lines using the most efficient routing. The drawings shown here are suggestions indicating the items needed for the installation.

CAUTION

To prevent adverse health issues, only materials (pipes, fittings, valves, solder, etc.) that are approved for use in potable water systems should be used.

1. Connect a 1-1/2" NPT coupler to the water heater's hot water connection.
2. Install a 1-1/2" union connection.
3. Install the supplied 3/4" 150 psi maximum pressure relief valve, as required by your local code into the port on the outlet pipe of the unit.
4. Following local building codes, install a 1-1/2" manual shut-off valve with 1-1/2" NPT fittings.

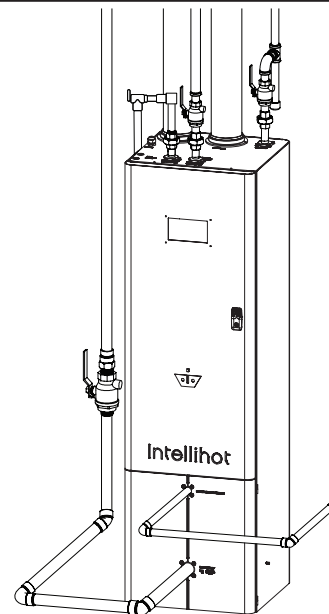

Note: Wye-Strainer and gas regulator not shown for clarity.

WARNING

To prevent serious personal injury, do not install any shut-off device between the water heater and the pressure relief valve. This valve is designed to release abnormally high pressure within the water heater in the event of a system problem.

NOTICE

The pressure relief valve must be rated at 150 psi, the maximum btu/h output of the unit, and comply with all local building codes and standards. Do not install any restrictions or other valves before the pressure relief valve.

5. Install and route a discharge pipe from the pressure relief valve to within six inches of the floor and directed away from walkways or other appliances.
 - a. Route the relief valve to within six inches of the floor to prevent injury in the event of a discharge.
 - b. The diameter of the pipe from the relief valve must be equal to the outlet size of the relief valve.
 - c. Do not use reducers in the outlet pipe.
 - d. Do not install any valves, restrictions, elbows, or other blockages in the outlet pipe.
 - e. For multiple unit installations, the outlet pipes must not be connected together. Each pipe must be separately routed to a suitable drain.
6. Connect the unit to the building's hot water pipes. If multiple water heaters are being installed, the diameter of both the main cold water pipes and the main hot water pipes need to be sized by an engineering professional.
7. To conserve energy, insulate all hot water pipes and recirculation pipes.

**SAFETY
INSTRUCTIONS**

Do not insulate the pressure relief valve.

8. With the unit OFF, open a nearby hot water faucet and allow the water to flow through the unit until all the trapped air is exhausted from the water pipes and from the water heater.
9. Leak-test the water piping. Repair any leaks immediately.

8.3 Cold Water Connection

Install and connect the cold water pipes.

Note: If the incoming water is known to have a high mineral content or "hardness" (see "18. Warranty" on page 68), treatment is recommended upstream from the water heater.

When the water heater is installed in a closed loop recirculation system, and if the cold water supply pipe has a back flow preventer, then an expansion tank should be installed to allow for water expansion as per the diagrams in "3.7 Configuration Options" on page 9.

CAUTION

To prevent adverse health issues, only materials (pipes, fittings, valves, solder, etc.) that are approved for use in potable water systems should be used.

1. Connect a 1-1/2" NPT coupler to the water heater's cold water connection.
2. Install a 1-1/2" union connection.

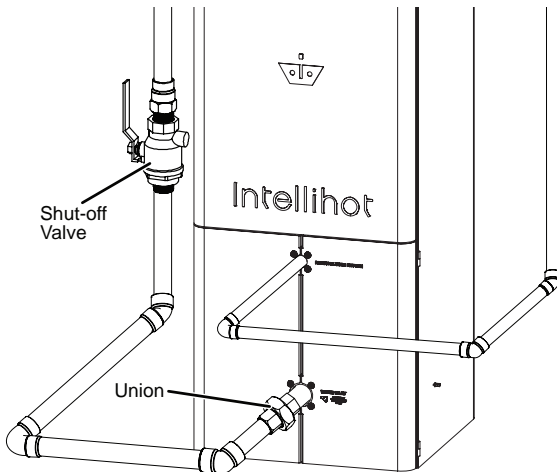

Note: Wye-Strainer not shown for clarity.

3. Following local building codes, install a 1-1/2" manual shut-off valve with 1-1/2" NPT fittings.
4. Connect the unit to the building's cold water pipes. If multiple water heaters are being installed, the diameter of the main cold water pipe needs to be sized by an engineering professional.

Note: Isolation valve kits can be used if incoming water treatment is anticipated (such as a water softener) due to hardness levels or heavy usage of the unit.

5. With the unit OFF, open a nearby cold water faucet and allow the water to flow through the unit until all the trapped air is exhausted from the water pipes and from the water heater.
6. Leak-test the water pipes. Repair any leaks immediately.

8.4 Condensate Drain Line

Due to its efficient design, the water heater produces condensate (water) as a normal by-product of heating the water.

This condensate is acidic, with a pH level between 3 and 4. Local building codes might require an in-line neutralizer to be installed (not included) to treat this water. The maximum condensate flow rate is 1.4 GPH.

1. Install a 3/4" flexible hose to the hose connection on the water heater.

Note: If a floor drain is used to remove the discharge, route the drain line over or into the drain. The line should freely drain. The line termination should not be immersed in water.

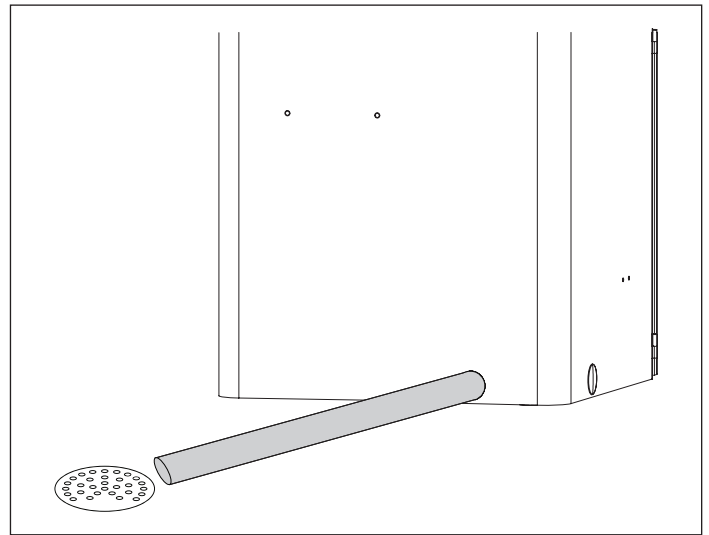

2. Follow applicable local codes and if required, install in-line neutralizer to treat the acidic condensate. Follow all the installation instructions included with the neutralizer.

9. Electrical Power

9.1 Electrical Recommendations

⚠ WARNING

To avoid serious injury or even death, follow all applicable local, state, and national regulations, mandates, and building codes for guidelines to install the electrical power supply.

Electrical code requirements are different in the USA and Canada. Refer to and follow the local building codes, and the latest edition of the National Electrical Code (NFPA 70) in the USA, or the CGA C22.1 Canadian Electrical Code - Part 1.

For a single iN199 water heater, the circuit breaker(s) should be at least 15 amps per circuit.

For multiple units, install an adequately sized circuit breaker. Installing a separate circuit breaker for each unit is recommended to isolate units during service or repair.

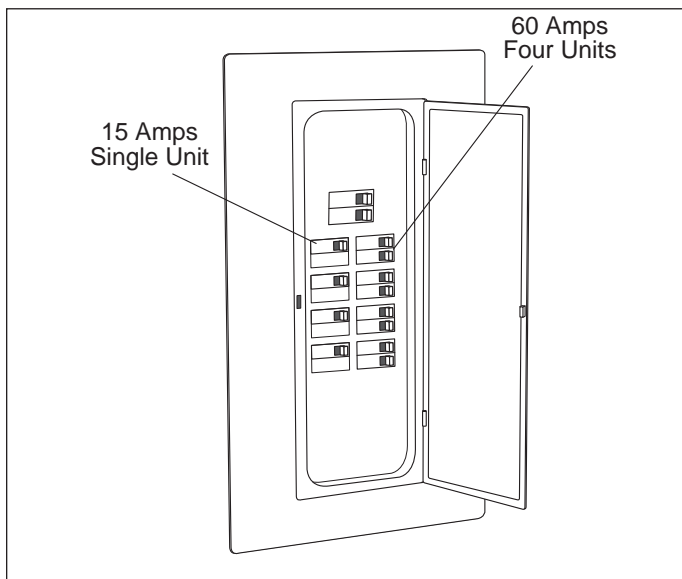

Note: For an electrical wiring schematic, refer to “15.2 Complete Wiring Diagram (all models)” on page 53 for additional information.

NOTICE

The electrical connections for the water heaters are polarity-sensitive. Before connecting the water heater to the power source, test the polarity of the electrical circuit.

9.2 Connection Instructions

1. On single-unit installations, make sure the electrical outlet being used is wired with at least 12-gauge wire and grounded with an appropriately sized circuit breaker. The electrical power required for the water heater is 120V AC at 60 Hz.
2. Remove the two cover screws and open the cover.

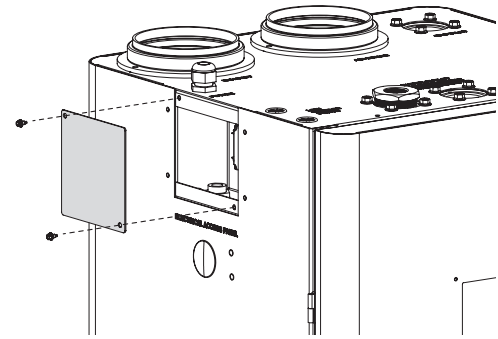

⚠ WARNING

To avoid serious injury or even death from electrical hazards, an additional ON/OFF electrical junction box should be installed near the water heater. This switch allows power to be removed from the water heater prior to service or in the case of an emergency.

3. Route a customer-supplied, appropriately-sized wire with ground from an electrical junction box with an ON/OFF switch through the back panel of the water heater. Route the wire through the cabinet to the junction box.
4. On the opposite side of the block from the factory-installed wiring, connect the white wire to the white terminal, the black wire to the black terminal, and the green ground wire to the green terminal (for each circuit).

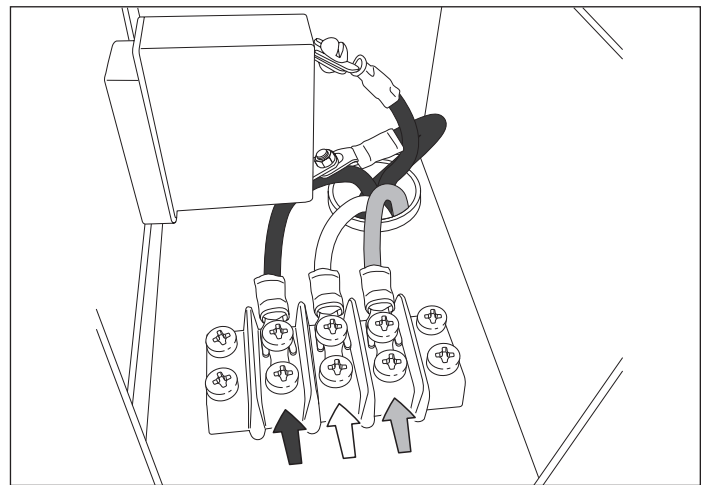

5. If multiple units are being installed, refer to “13. Connecting Multiple Units” on page 47 for additional information.

10. Adjusting CO₂ Level

10.1 General Information

This procedure is required:

1. Only during installation in a high-altitude location over 8,000 feet, or
2. When converting the unit from natural gas to propane.

This procedure should be completed only by a qualified technician.

⚠ DANGER

A concentration of carbon monoxide (CO) as small as 0.04% (400 parts per million) in the air can be fatal. When making High Fire and/or Low Fire adjustments, CO levels must be monitored using a flue gas analyzer and must not exceed 400 ppm of CO at any time during the operation.

Adjusting the “Low Fire screw” or the “High Fire screw” even in small increments can result in a significant increase in CO concentration. To avoid serious injury or death, DO NOT adjust the gas valve without monitoring the exhaust gases with a functional and calibrated flue gas analyzer.

CO ₂ and CO Standards		
Description	CO ₂ Range (%)	Max. CO Level (ppm)
Natural Gas		
High Fire	9.1% to 9.3%	< 200 ppm
Low Fire	9.1% to 9.3%	< 60 ppm
Propane		
High Fire	10.1% to 10.5%	< 200 ppm
Low Fire	10.1% to 10.5%	< 60 ppm

NOTICE

1. The values listed in the table are for nominal conditions. Variables such as gas pressure, heating value of the gas, humidity, and temperature of combustion air can impact CO and CO₂ values. Changes in these variables can result in different CO and CO₂ values on the same water heater.
2. A qualified service technician must use a calibrated flue gas analyzer to adjust the gas valve to achieve the desired CO₂ and CO values.
3. Before any adjustments are made, the service technician must confirm the static gas pressure meets these minimum requirements: Natural Gas - 8" WC; Propane - 11" WC.
4. If units are cascaded and common-vented, these combustions must be done on only one unit at a time. Turn off the valve to the hot water outlet of the other units and power off before doing combustion.

10.2 Adjustment Procedure

1. Open or remove the front doors.
2. Locate the gas valve as shown in illustration.

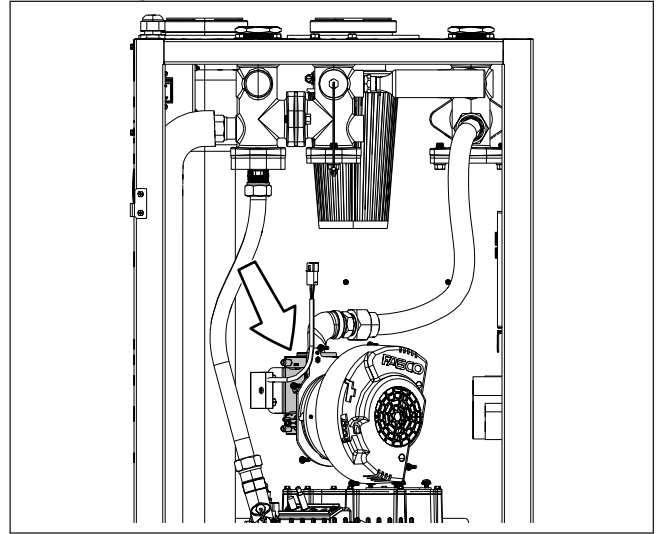

3. Remove the plug from the test port on the exhaust manifold.
4. Insert a calibrated flue gas analyzer into the test port.
5. Follow the display screens.

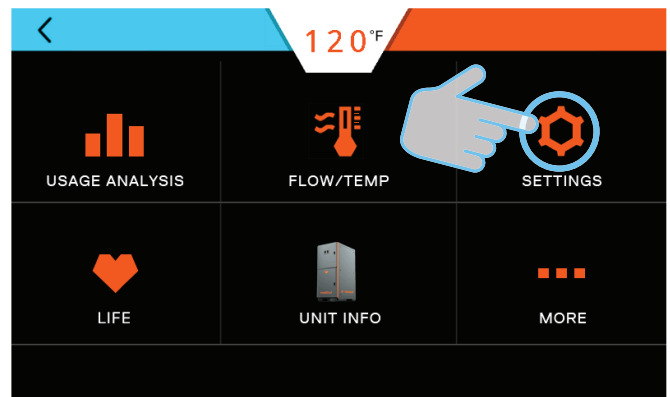
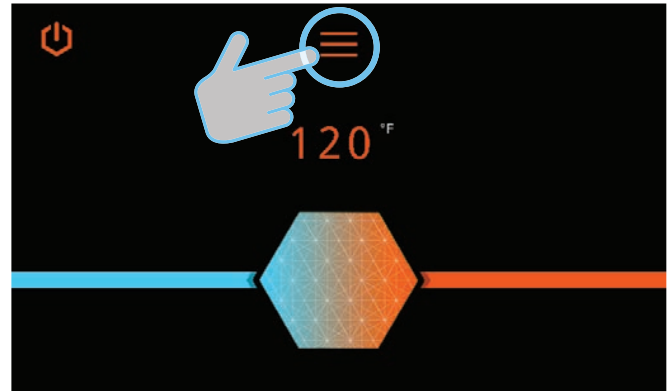

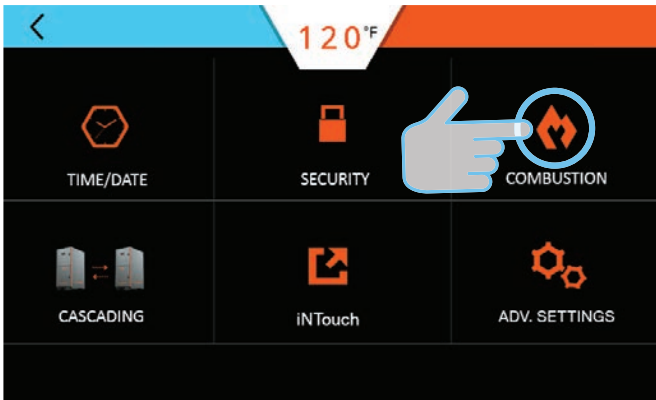

11. If the CO₂ values are within appropriate range, proceed to Step 12, otherwise continue.
 - a. Use a flat-blade screwdriver to turn the High Fire screw clockwise to decrease and counterclockwise to increase the CO₂ value.
 - b. Adjust in ¼ turn increments.
 - c. Wait three minutes to stabilize flue gas readings and recheck values.
 - d. Adjust until values fall with specified range.

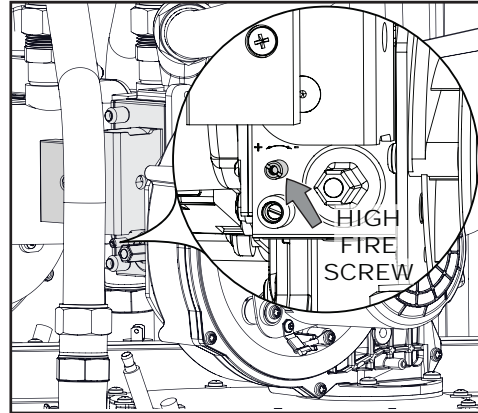

12. After the desired values are achieved, record the new High Fire CO₂ "adjusted values" in the table.

CO ₂ and CO Standards		
Description	CO ₂ Range	Max. CO Level
Natural Gas High Fire	9.1% to 9.3%	< 200 ppm
Propane High Fire	10.1% to 10.5%	< 200 ppm

High Fire Recorded Values		
Date ____ / ____ / ____		
Heat Engine	Initial Output	Adjusted Value
CO ₂ Value %		
Max CO ppm		

NOTICE

Do NOT change the blower speed settings. This adjustment MUST be completed by factory personnel ONLY. Changing this setting VOIDS the warranty!

6. Create a hot water flow of at least 6.0 GPM as shown on the display screen.



Note: If flow rate is inadequate, a pop-up message notifies you to increase the flow.

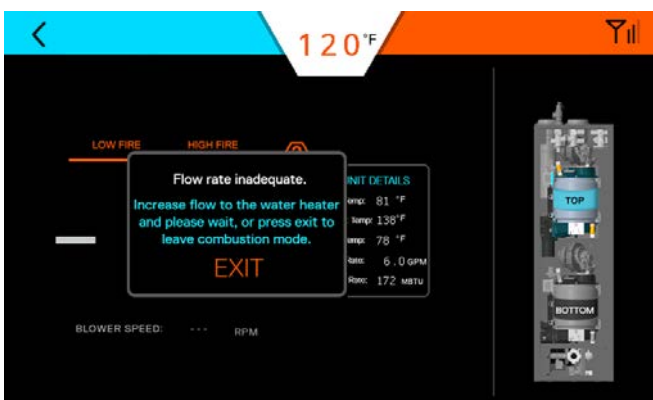

7. At a flow rate of 6.0 GPM, the heat engine starts.
8. Press HIGH FIRE on the display screen.
9. Allow three minutes of operation at High Fire.
10. Record "initial output" in Hire Fire Recorded Values table.

13. Press LOW FIRE on the display screen.



14. Record “initial output” in Low Fire Recorded Values table.

CO ₂ and CO Standards		
Description	CO ₂ Range	Max. CO Level
Natural Gas Low Fire	9.1% to 9.3%	< 60 ppm
Propane Low Fire	10.1% to 10.5%	< 60 ppm

Low Fire Recorded Values		
Date ____ / ____ / ____		
Heat Engine	Initial Output	Adjusted Value
CO ₂ Value %		
Max CO ppm		

15. Adjust the Low Fire screw while the burner operates at low fire using a 2mm hex wrench. Turn clockwise to increase CO₂ and counterclockwise to decrease CO₂.

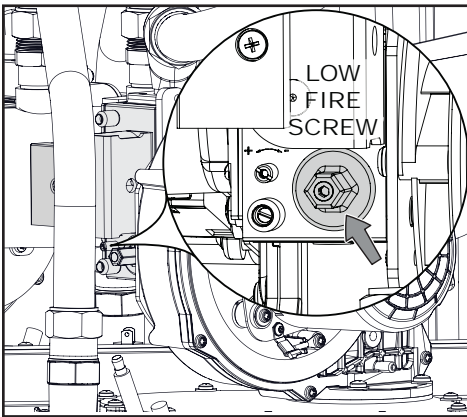

16. After the desired values are achieved, record the new Low Fire CO₂ “adjusted values” in the table.
17. After the heat engine is properly adjusted, turn off the water flow.
18. Remove the flue gas analyzer probe and plug the test port.
19. Press the back button to return to the main screen.
20. Check for gas leaks using a leak detector.
21. Install side panel covers. If converting to propane, proceed to section “11. Natural Gas to Propane Conversion” on page 34.

11. Natural Gas to Propane Conversion

**SAFETY
INSTRUCTIONS**

A qualified service technician MUST make the required changes to convert the water heater from natural gas to propane.

11.1 General Information

Note: This conversion process also requires the CO₂ levels to be adjusted. Refer to “11. Natural Gas to Propane Conversion” on page 3410. Adjusting CO₂ Level” on page 31.

Before converting the unit for propane, verify the current gas inlet pressure meets the recommended pressure and record it in the space below.

Propane Static Gas Pressure	
Parameters	Specifications
Minimum Static Gas Pressure	8" WC (non-corrugated, black iron)
Recommended Gas Pressure	11" WC
Maximum Static Gas Pressure	13" WC

Current Static Propane Gas Pressure _____WC

Date _____

11.2 Conversion Procedure

- Follow these steps before repositioning the DIP switches.
 - Turn the water heater OFF using the display screen.

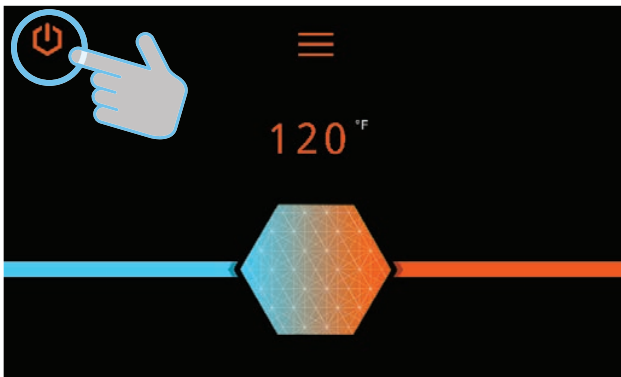

- Place the circuit breaker for the water heater at the main electrical panel in the OFF position. Verify there is no power to the unit(s).

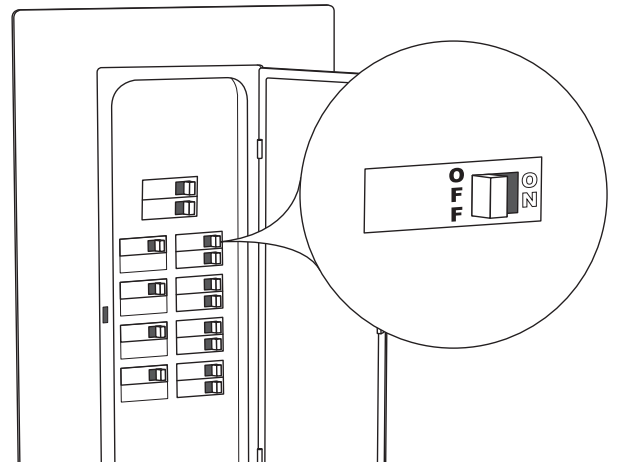

- Open the front door and locate the main circuit board.
- Locate DIP Switch 1 on the circuit board.

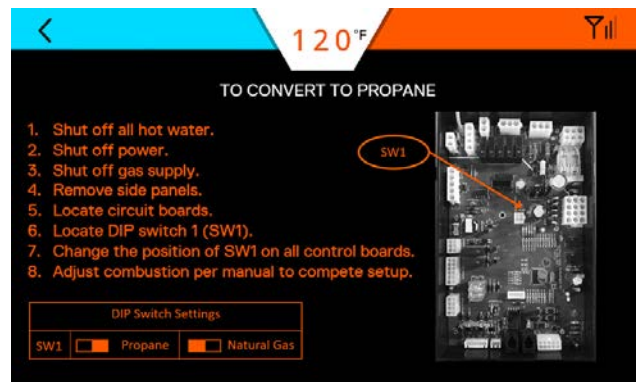

- Move DIP switch downward into the Propane position.

DIP Switch Settings (Réglages des commutateurs DIP)				
SW1	ON ↓	Propane	ON ↑	Natural Gas (Gaz naturel)

f. Reset the circuit breaker to the ON position. Turn the water heater ON using the display screen.

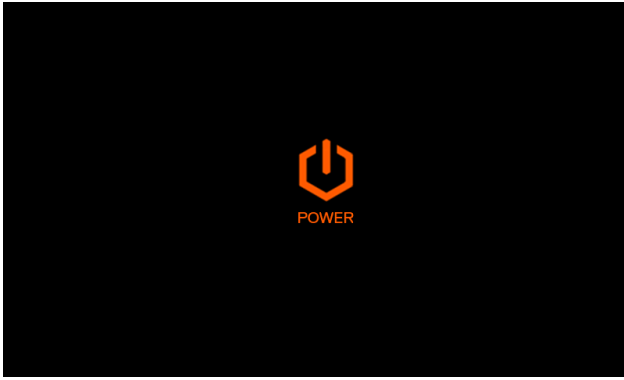

2. Follow the display screens to check if the unit is now set to propane.

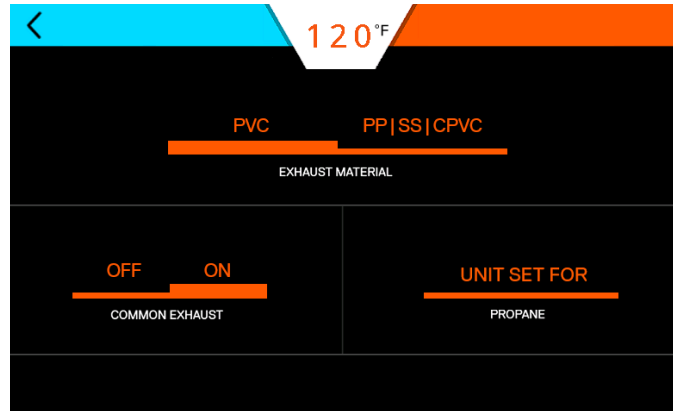
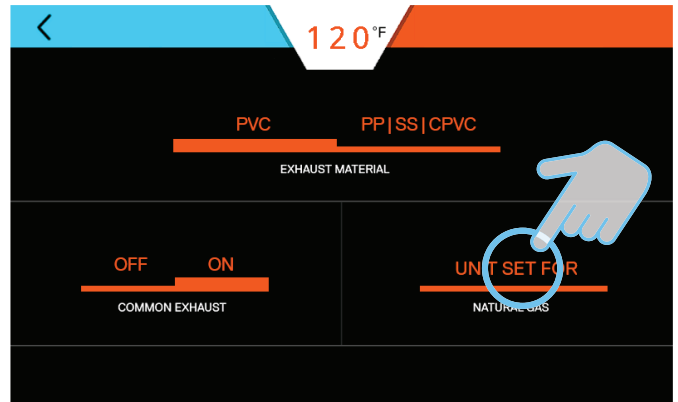
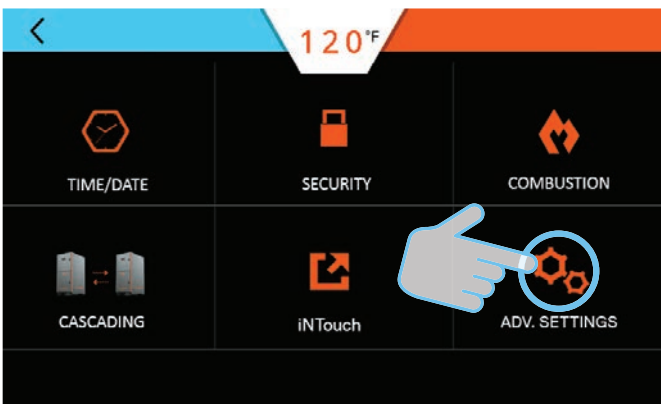
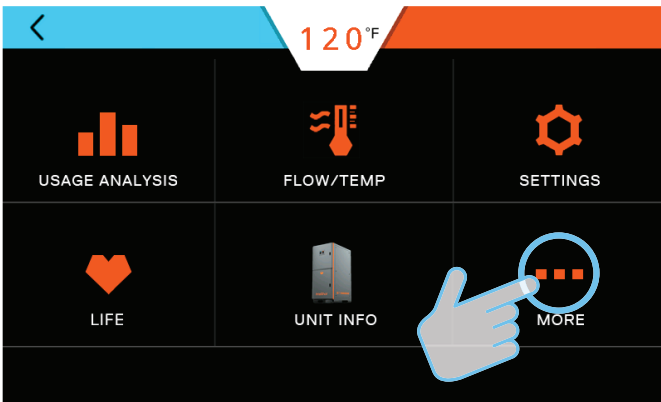
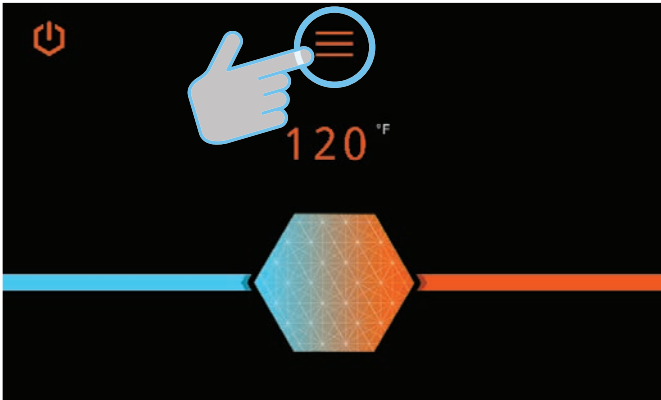

12. Operation

12.1 Control Panel

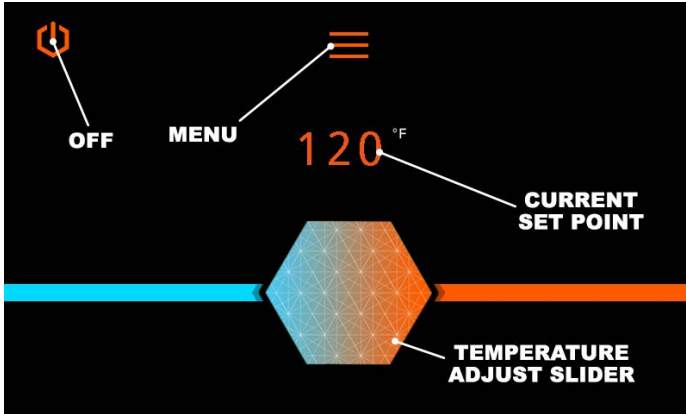

Main Menu Screen

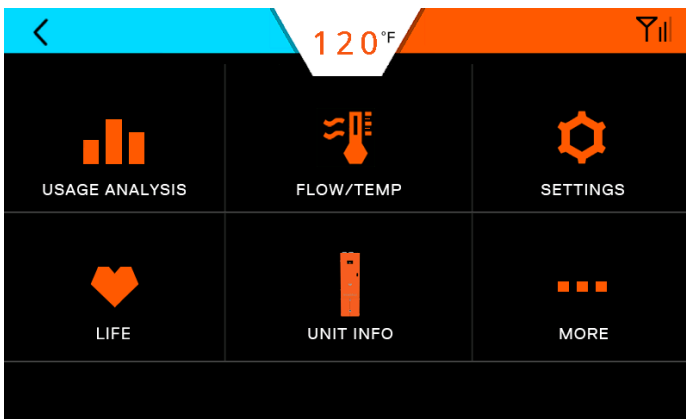

Selecting the Menu button brings up this screen.

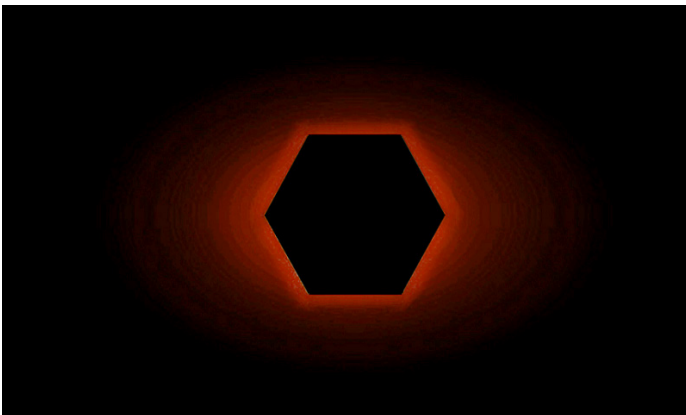

A sleep mode screen is displayed after a period of inactivity.

12.2 Turning Water Heater ON and OFF

1. When power is applied to the water heater or the electrical switch is turned ON, the Main Menu screen automatically appears.



2. To turn the water heater OFF, press and hold the POWER button in the upper left of the screen.

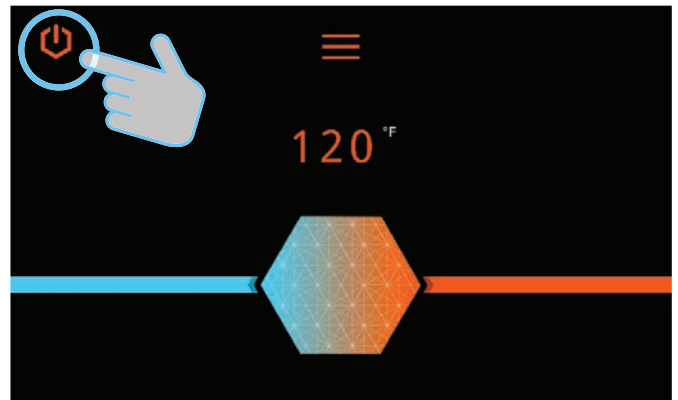

3. Press the POWER button to turn the unit ON.

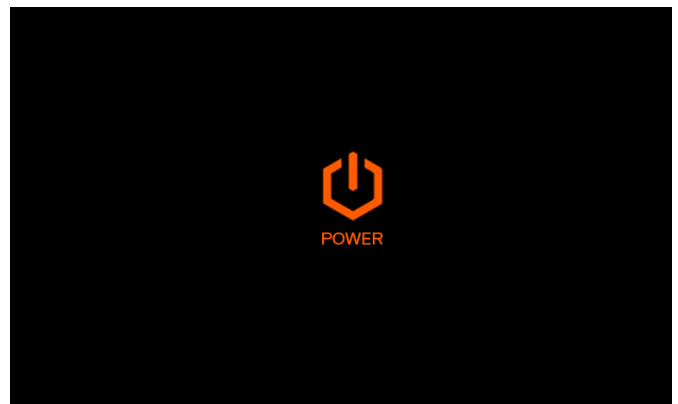

WARNING

Turning the unit OFF does not disconnect it from the power source. Whenever working around electrical components within the water heater, turn off the power at its source. Touching live electrical components can cause serious injury or death.

12.3 Setting the Time

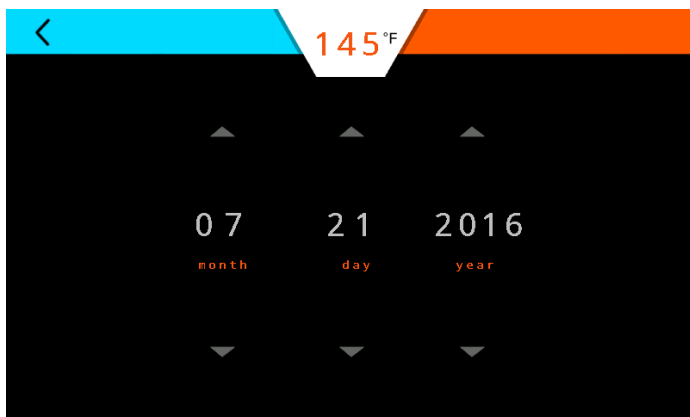
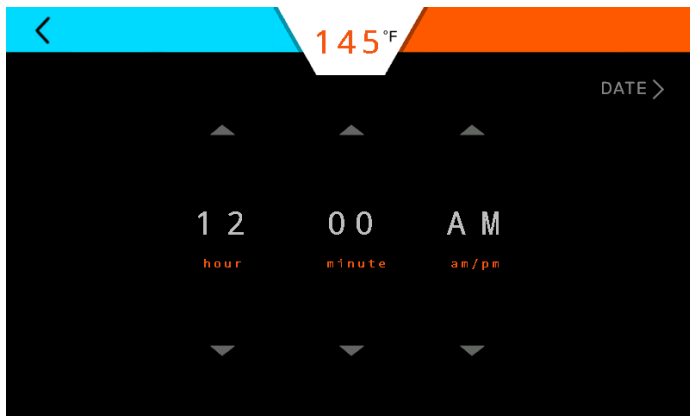
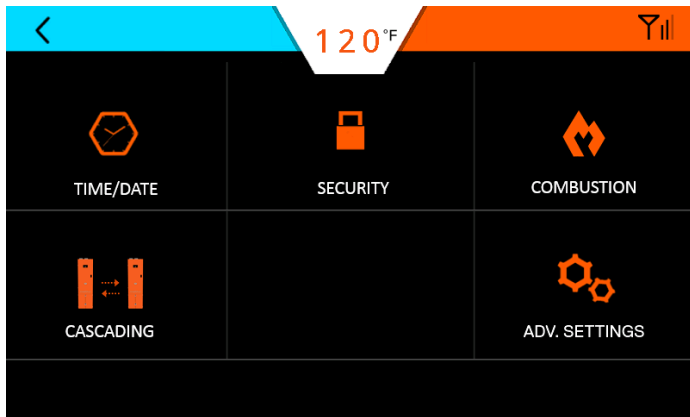
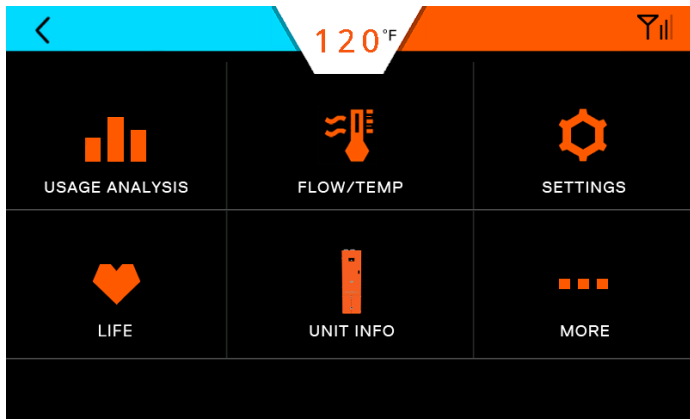

Press the UP/DOWN arrows to make adjustments. Press the BACK button to return to the main screen.

12.4 Adjusting the Water Temperature

Note: The outlet water temperature is factory preset to 120°F, however these commercial water heaters can heat water to 190°F.

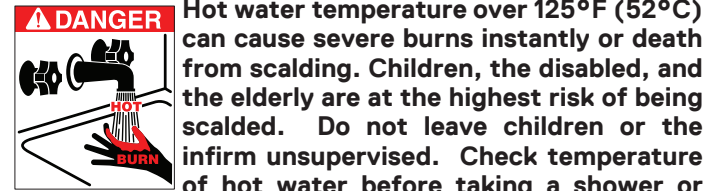

DANGER Hot water temperature over 125°F (52°C) can cause severe burns instantly or death from scalding. Children, the disabled, and the elderly are at the highest risk of being scalded. Do not leave children or the infirm unsupervised. Check temperature of hot water before taking a shower or bath. To control water temperature to a particular faucet, temperature limiting valves can be installed by your service professional.

All water faucets must be closed before changing the temperature setting. The unit must not be operating.

1. Firmly press the (+) and (-) to increase or decrease temperature. Firmly hold the icon until the display reaches the desired temperature.

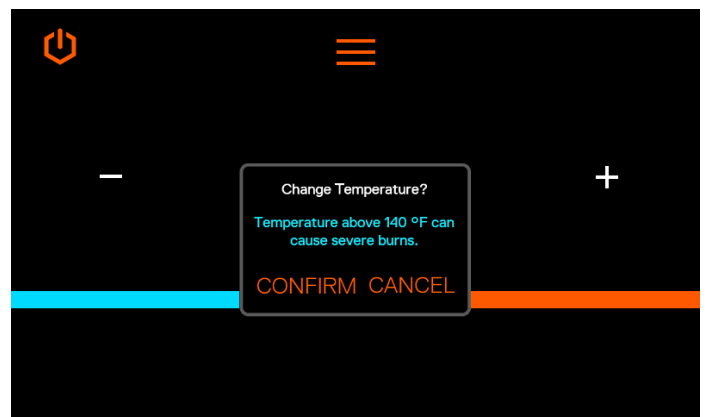
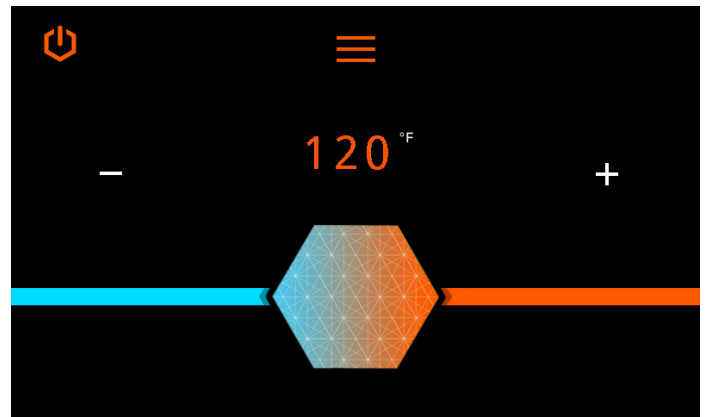

2. For finer temperature adjustments, tap the (+) and (-) icons.

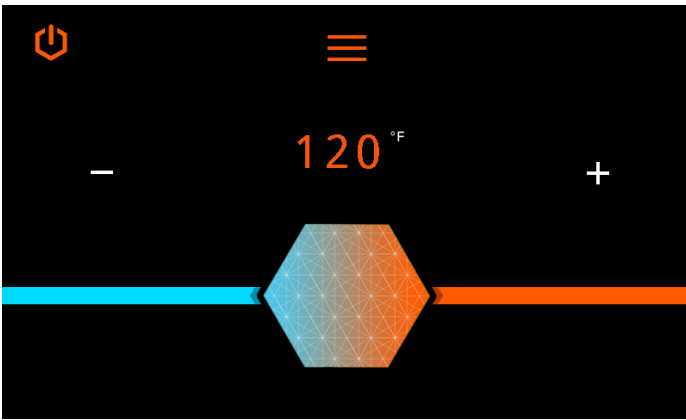

12.5 Security

12.5.1 Setting Passcode Protection

It is not necessary to set a passcode for the water heater to function properly. This feature is available to help prevent unauthorized access to the unit.

If a passcode is set, it must be entered prior to accessing the main screen.

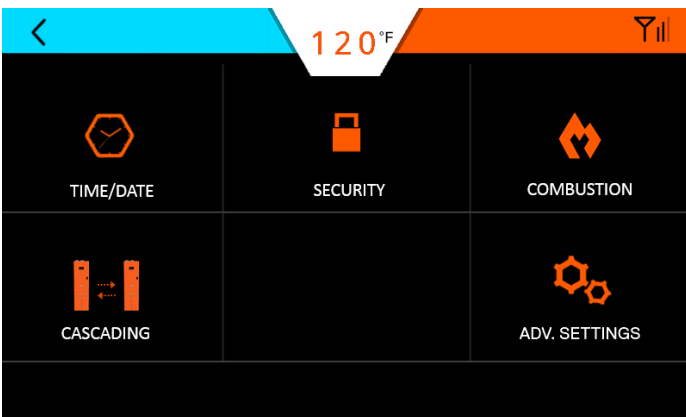
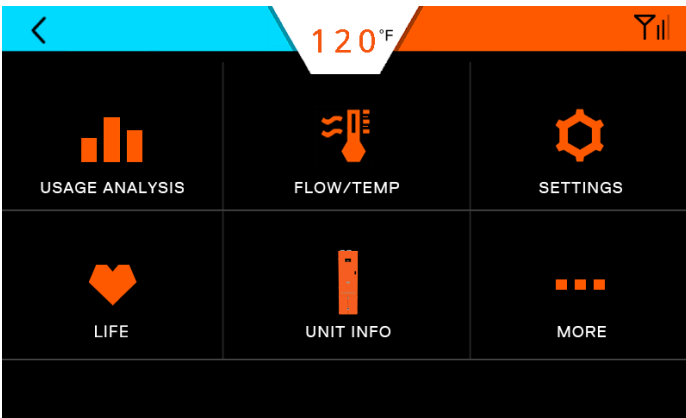

Press ON/OFF and follow the prompts.

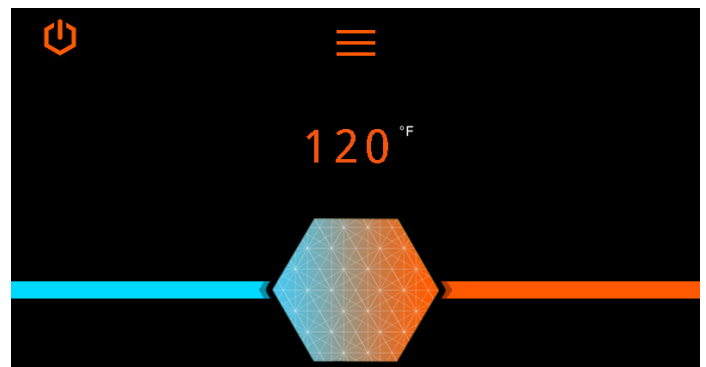
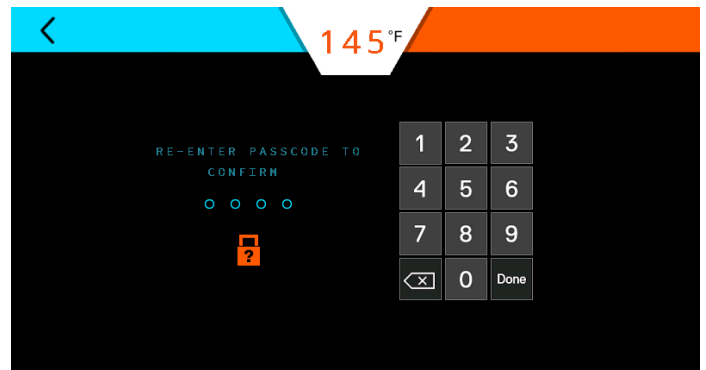
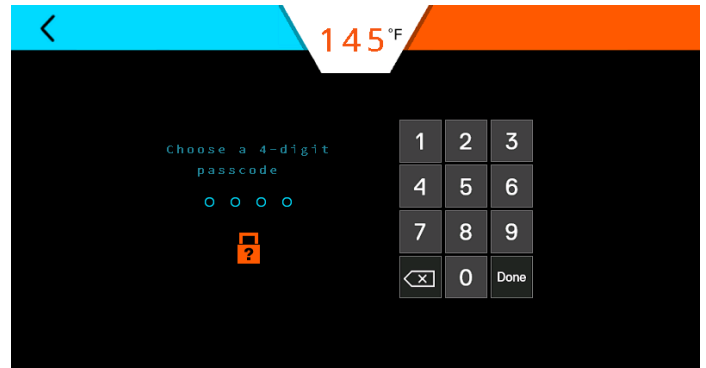
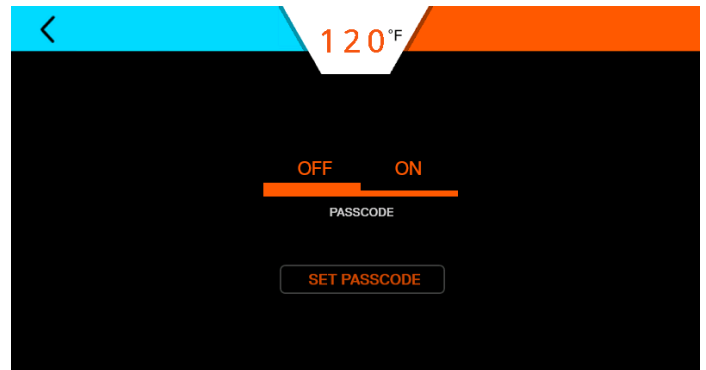

12.5.2 Changing Passcode

1. Press CHANGE PASSCODE and follow the prompts.

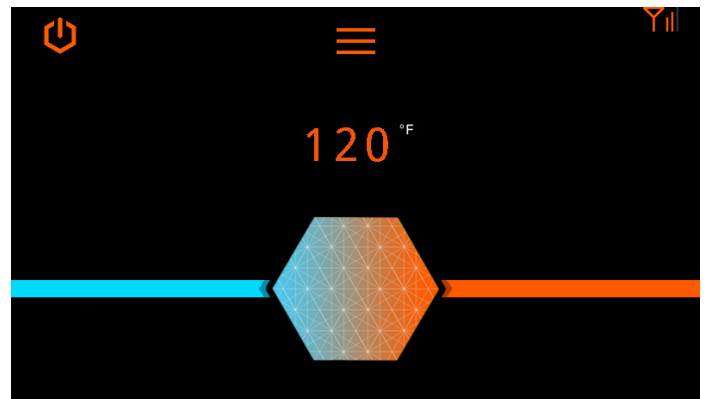
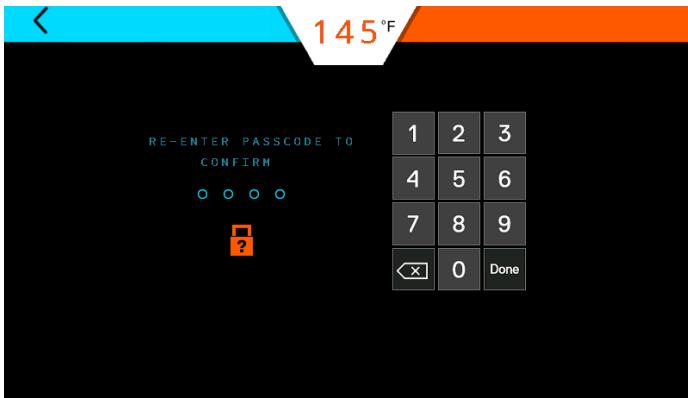
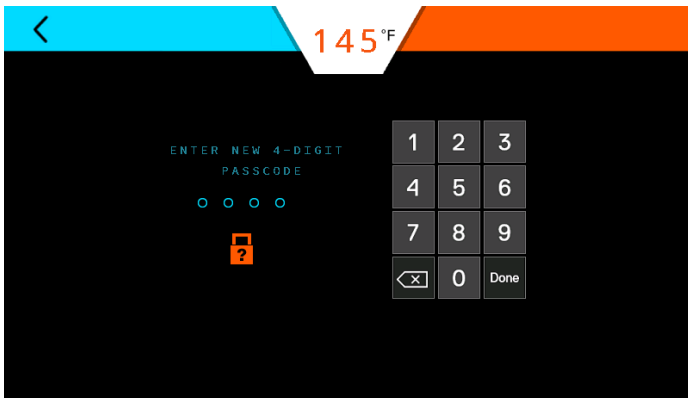
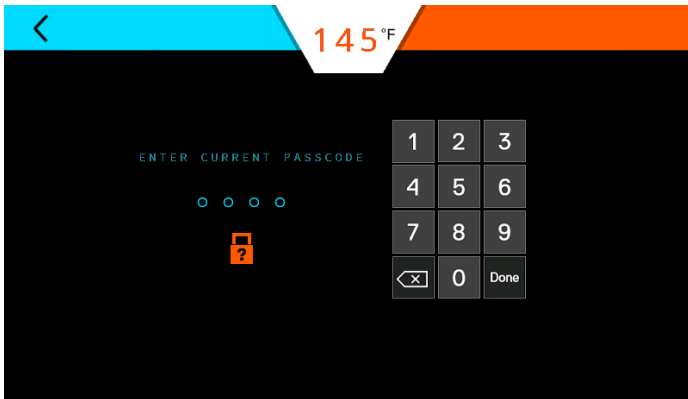
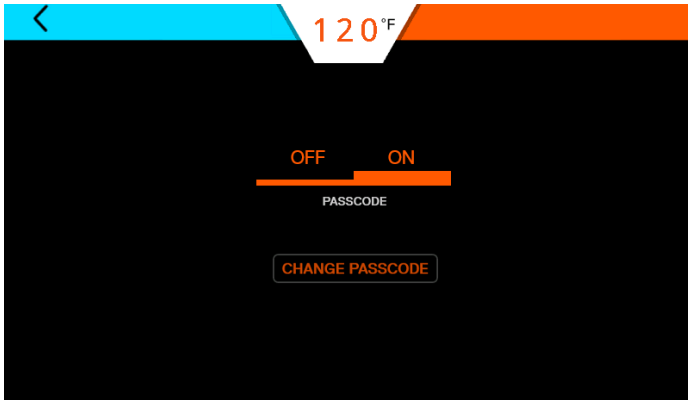

12.5.3 Forgot Passcode

If the unit passcode is lost or forgotten, press the “?” icon and call technical support.

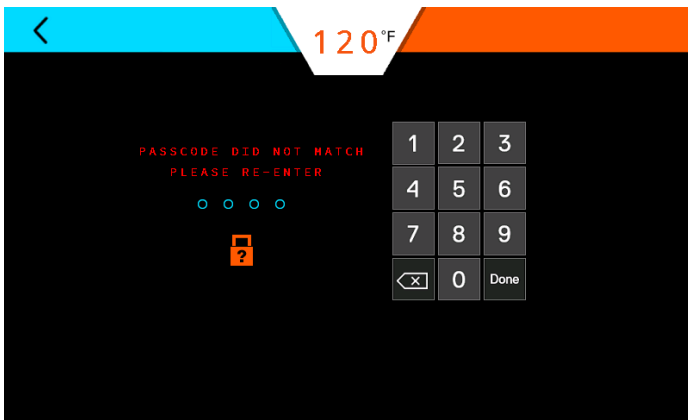
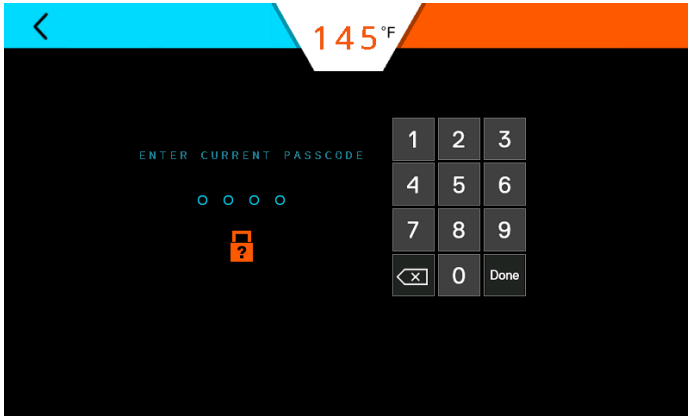

12.6 Unit Overview

Provides the general operating parameters of each heat engine.



12.7 Life Screen

These screens display the remaining life of various components.

Note: Parts can be ordered by contacting technical support.

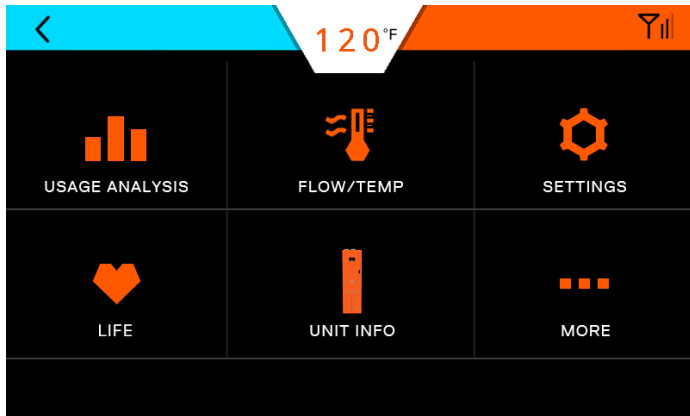

Service recommended: Order appropriate replacement part as soon as possible. To reset life, press and hold the appropriate bar and follow the prompts.



Service Required: Take IMMEDIATE action when this screen appears because the part life is critical. To reset life, press and hold the appropriate bar and follow the prompts.

When a part is replaced, the screens provide replacement part information and a screen to reset the service meter for the part being replaced.

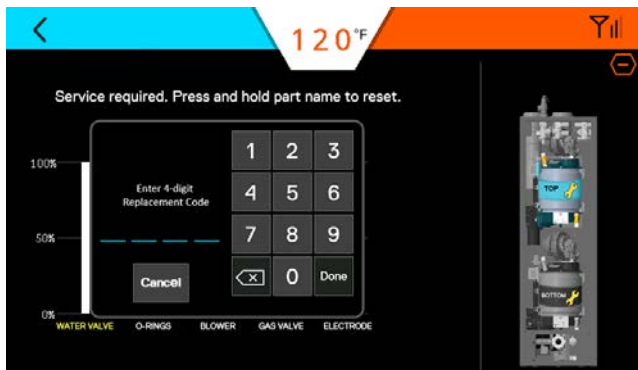
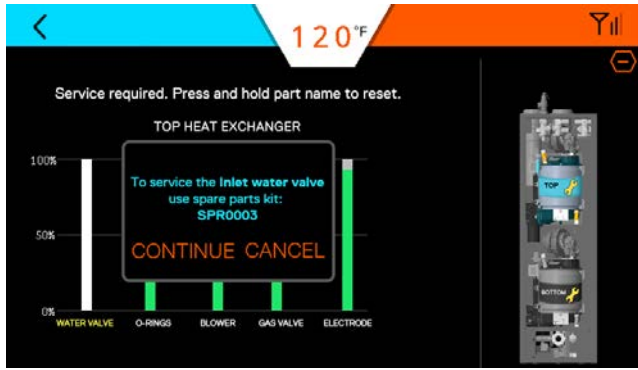

Service Alert	Reset Code
Electrode	0836
Blower	2009
Time Valve (Water Valve)	0721
Gas Valve	0682
O-Ring (at the HEX inlet and HEX outlet)	0310
Internal Pump	6452

12.8 Unit Information

This screen provides the model, software version, serial number, and a link to the “contact us” screen for the water heater.

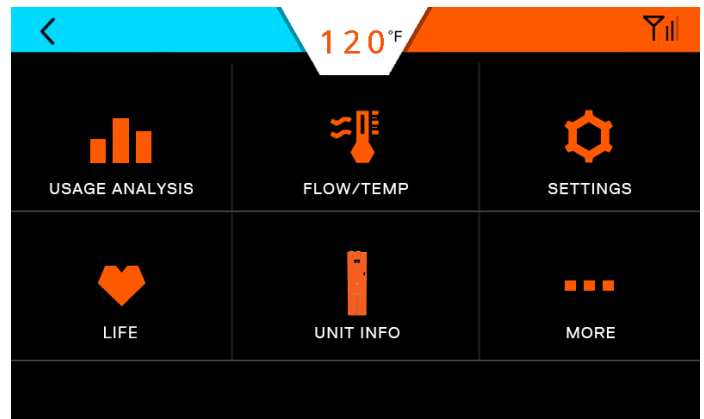

12.9 More Screens

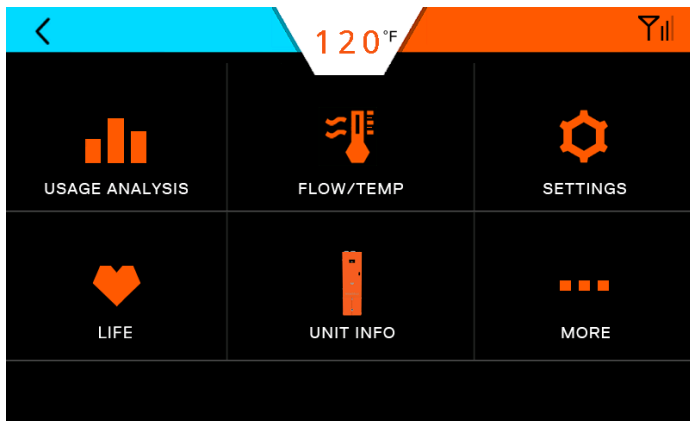

12.9.1 Cellular

Intellihot Gen II water heaters are cellular-capable. This feature allows the units to be monitored and controlled from a mobile device.

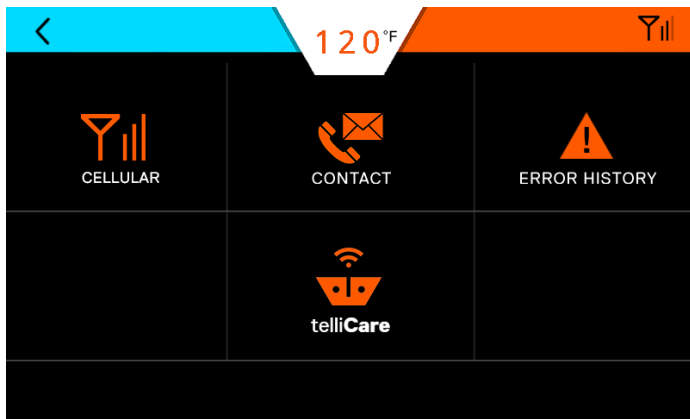

Status of cellular connection screens.

Whenever software updates are being made, the following screens are displayed.

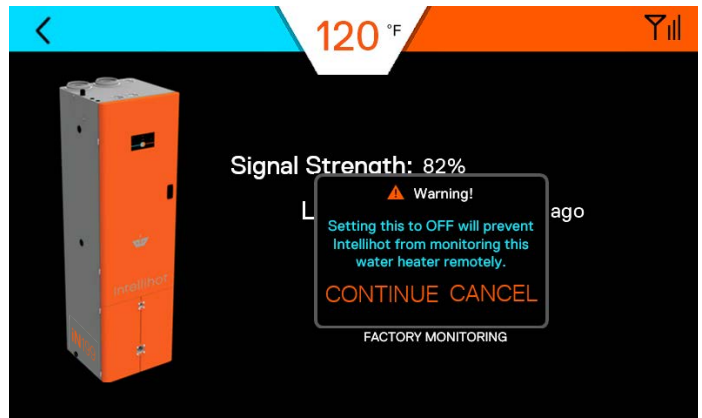

12.9.2 Error History

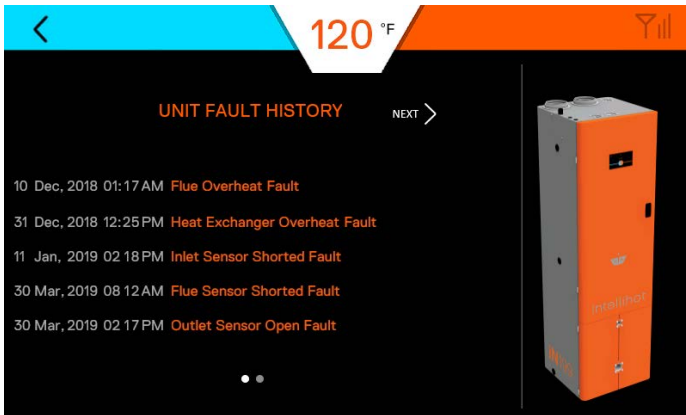
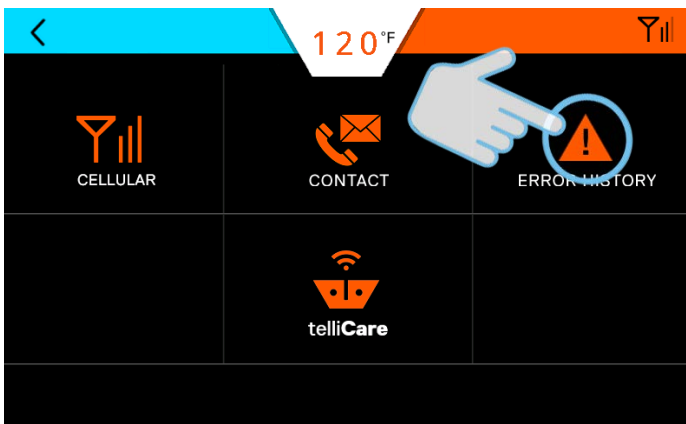

12.9.3 telliCare Service (Subscribe at Startup)

telliCare is a Wi-Fi enabled, prognostics and predictive maintenance service for Gen II water heaters. This service allows water heaters to be monitored and controlled remotely via an app on a mobile device.

Subscribe to this service by downloading the telliCare app from iTunes App Store and following the prompts on the app.

Upon startup the following screens are displayed.

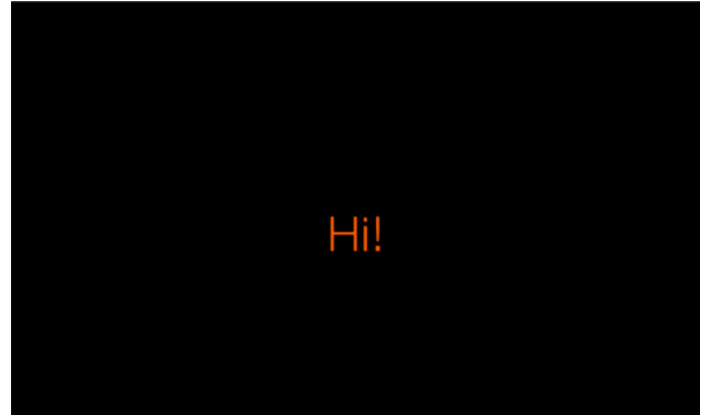

1. Tap anywhere on the screen to continue.

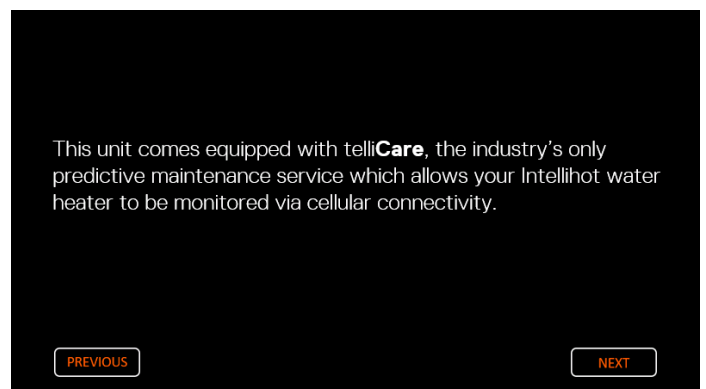
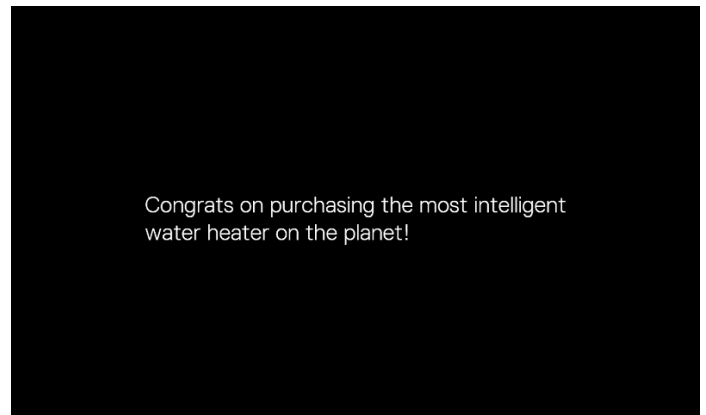

2. This screen appears as the unit is trying to find a cellular connection.

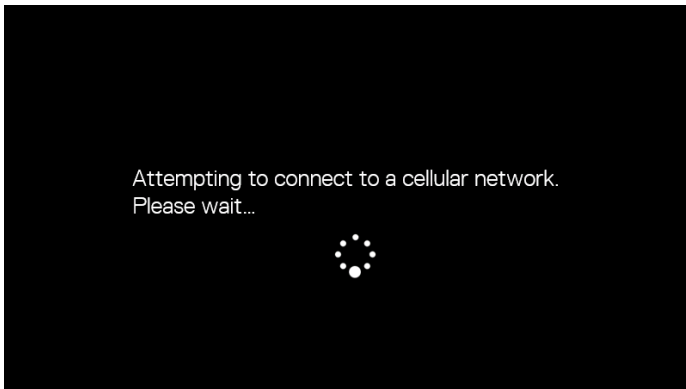

3. If the unit cannot find a connection, this screen appears.



4. If the unit can find a connection, the following screens appear.

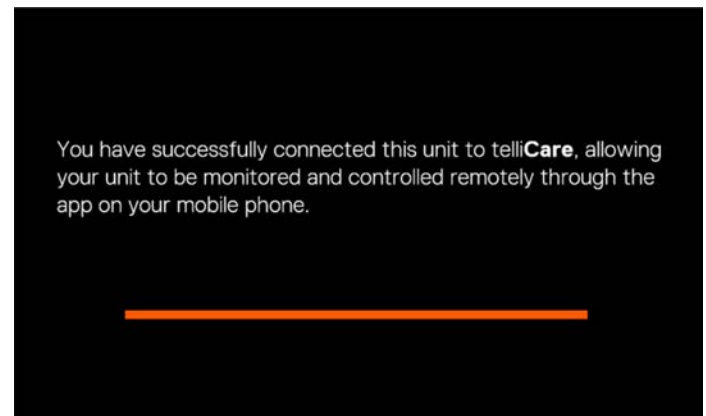
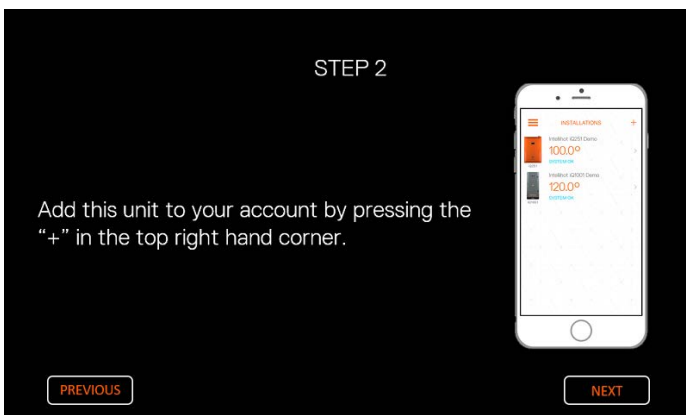
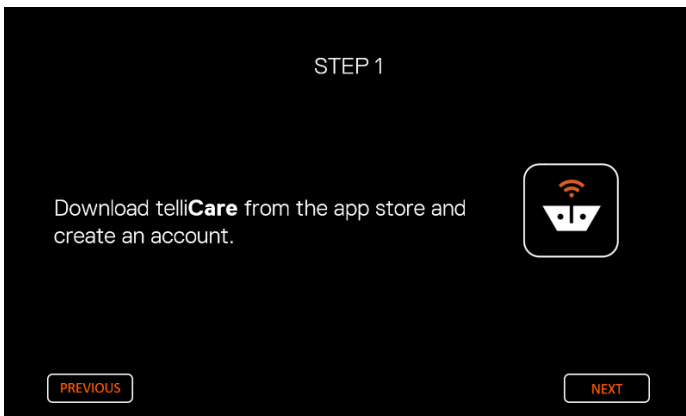

5. If the setup is not completed, the following screen appears:

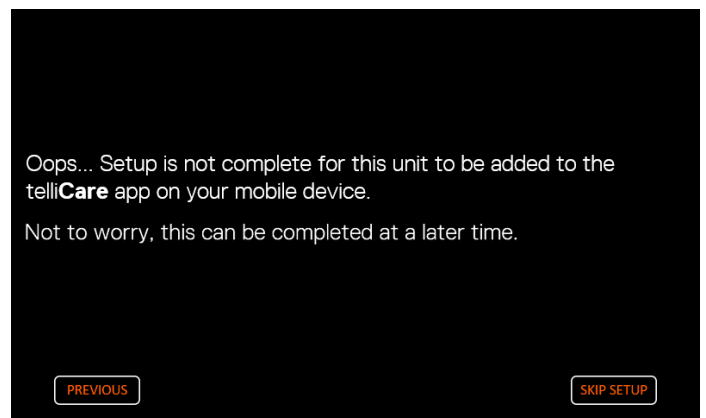

6. If the SKIP SETUP button is selected, register the unit by scanning the QR Code via the App. Select FINISHED when complete.

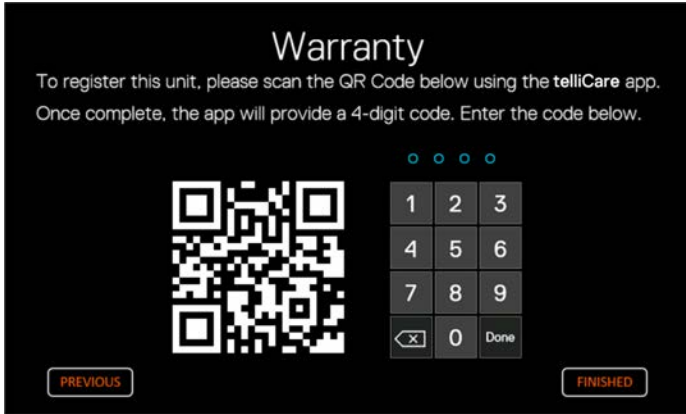

7. **Note:** Each individual unit must be registered and each unit can be registered only once.

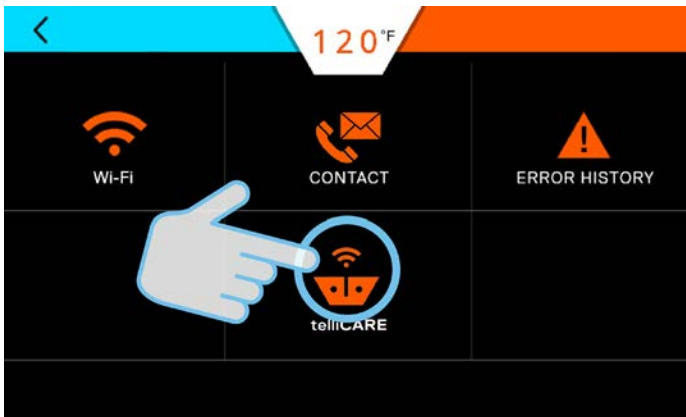

8. After the service is set up, two status screens provide the expiration date of the service and whether it is on an auto renewal schedule.

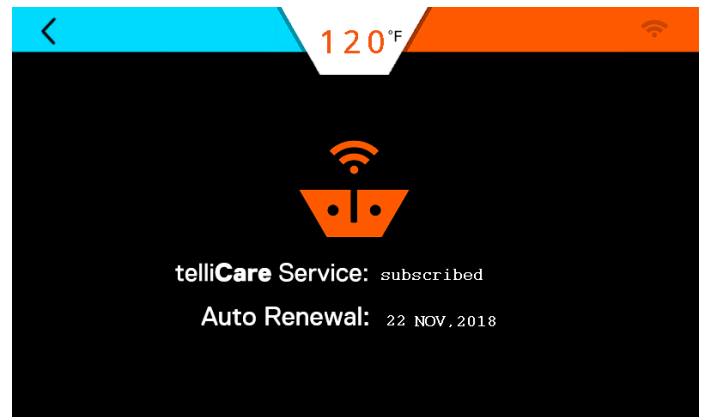

13. Connecting Multiple Units

13.1 General Information

Multiple units can be connected together to supply large demands for hot water.

The water heaters communicate through a cable connection between each water heater. The benefits of connecting the units are:

- When demand for hot water is low, fewer units operate.
- If one unit has an error code, the others continue to operate.
- Changing the settings (temperature, time, etc.) on one unit changes settings on all the units.
- It allows shutdown of one unit for maintenance while the others continue to operate.

13.2 Installation Procedure

1. Connect all the units to a gas supply pipe. Make sure the pipe is properly sized in accordance with the BTU draw and number of units being operated. Refer to “6. Gas Connection” on page 14 for additional information.
2. Connect all the units to the power supply. Refer to “9. Electrical Power” on page 30 for additional information.

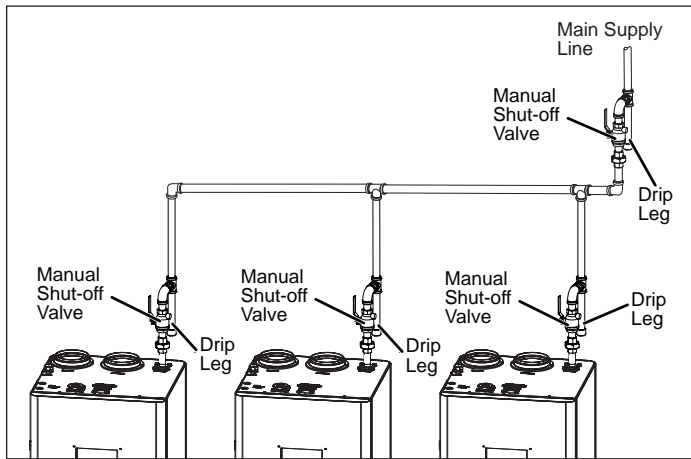

Note: Individual gas regulators not shown for clarity.

3. Install the combustion (fresh) air intake and exhaust outlet pipes. Refer to “7. Air Intake Inlet and Exhaust Gas Outlet Pipe Connections” on page 19 for additional information.
4. Install and connect the hot water lines. If an optional hot water storage tank is required, connect the hot water lines to this tank. Make sure the water pipe is properly sized in accordance with the number of units being operated.
5. Install and connect the cold water lines. Make sure the water line is properly sized in accordance with the number of units being operated.
6. Connect and route the condensate drain lines to a suitable discharge location. Refer to “8. Water Connections” on page 28 for additional information.
7. **Do Not** connect communication cables at this time.

8. Power up all the units and assign a unique number, one through four, to each unit. Set the STAGING to ON.

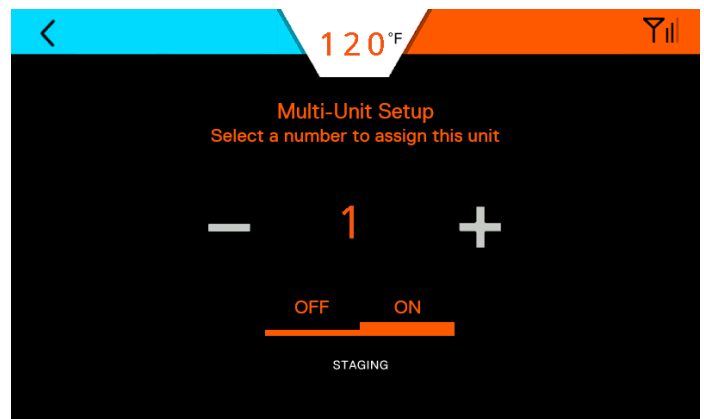
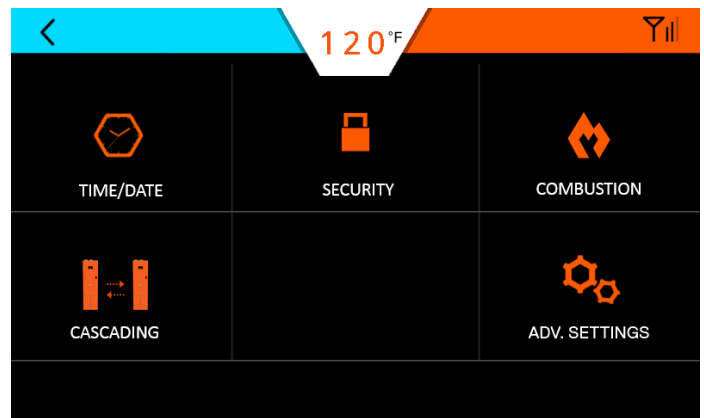
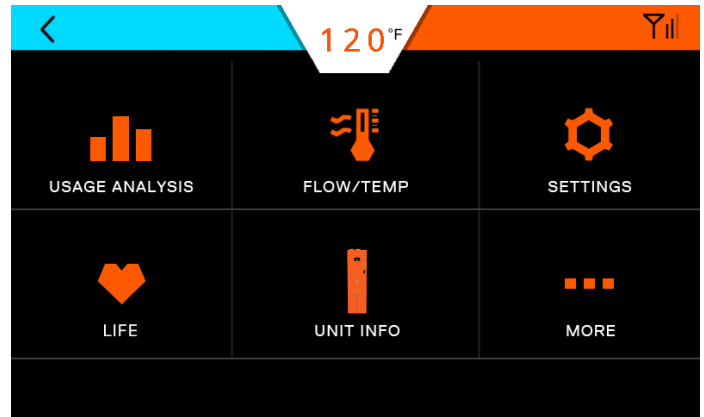

WARNING

Before making any adjustments or connections inside the water heater cabinet, make sure the power is disconnected. Unplug the water heater, turn the circuit breaker OFF or both.

9. If necessary, press the POWER button to turn OFF each water heater in the system and disconnect power from all the units in the system.

- Open the front door and locate the main circuit board.

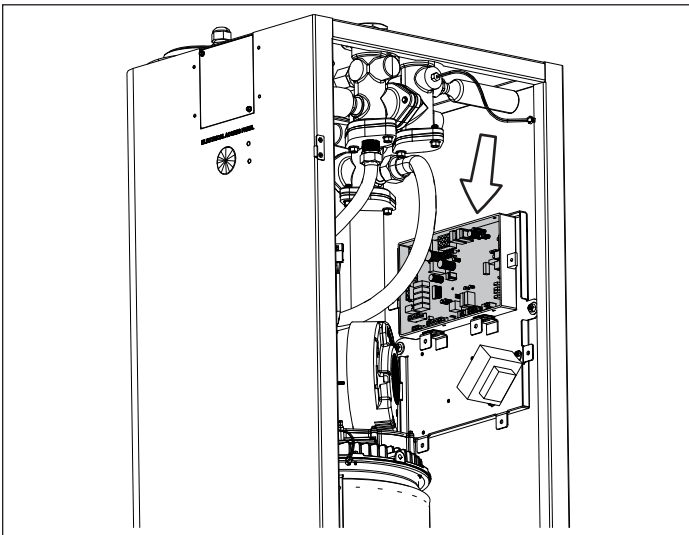

- Connect the included communication cable from an open jack on the circuit board in one unit to an open jack in the next unit. Repeat this step as required by the number of water heaters being connected.
- On the first water heater, locate DIP Switch 3 on the circuit board. Position the switch in the ON position (left).
- On any water heater unit between the first and last unit, position all DIP SW3 switches in the OFF position (right).
- On the last water heater, locate DIP Switch 3 and position the switch to ON.
- Once the communication cables are routed and connected and the DIP switches are correctly positioned, close and lock the front door.
- Reconnect the power and turn the water heater ON. The water heaters should now be ready to communicate with each other and operate as a single system.

Note:

- Whenever a change is made to any one water heater, all the other units in the system are automatically updated to the new settings.
- If cascading multiple units, the cellular module on all units besides unit #1 in the sequence need to be disconnected to make room for communication cables. Remove the attached cable at each end from referenced jacks and set aside.

13.3 Venting for Multiple Units

When venting for multiple units, the following screens appear.

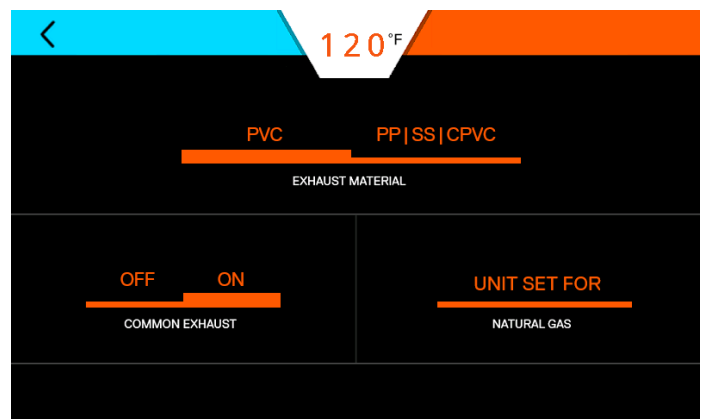
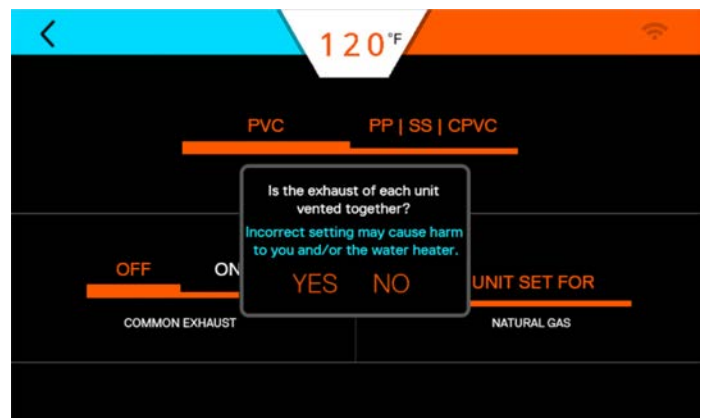
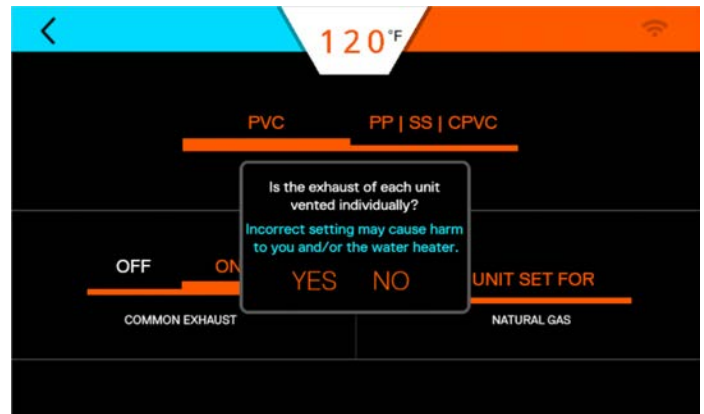

14. Maintenance

14.1 Maintenance-Free Circulation Pump

The circulation pump is maintenance-free and does not require any servicing. The only adjustment is the speed setting, which must be set to Speed 3 (III).

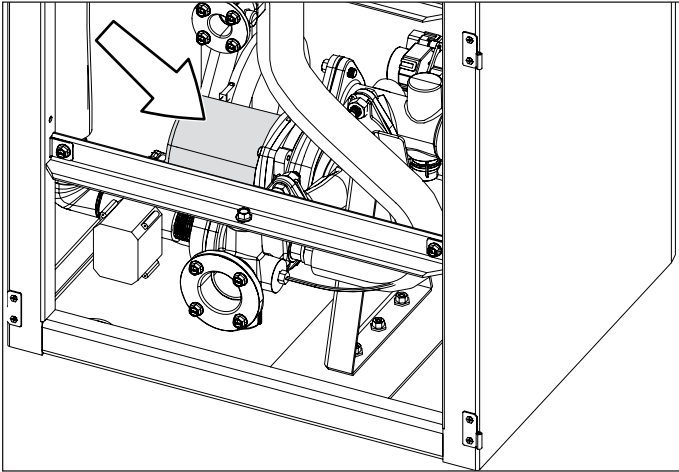

NOTICE

This heater includes an external Wye-Strainer. The Wye strainer must be installed to qualify for unit warranty.

Clean the Wye strainer every 3 months.

Take out and clean the internal condensate hose. Refill it with fresh water and reconnect it. This needs to be done every 3 months.

14.2 Air Filter

14.2.1 Inspection

Check the filter every six months for dirt and dust build-up. Clean and re-oil the filter annually. If the filter is dirty, follow the cleaning procedure.

Note: The air filter is manufactured by K&N. Contact K&N at 800-858-3333 or online at www.knfilters.com for the necessary supplies to clean the filter.

1. Loosen the band clamp and remove the air filter.

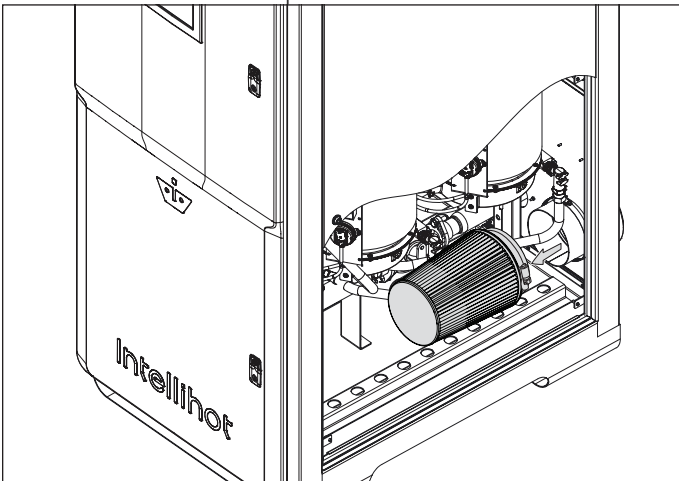

2. Inspect the inside of the filter for dirt and dust build-up. Clean the filter, if needed.

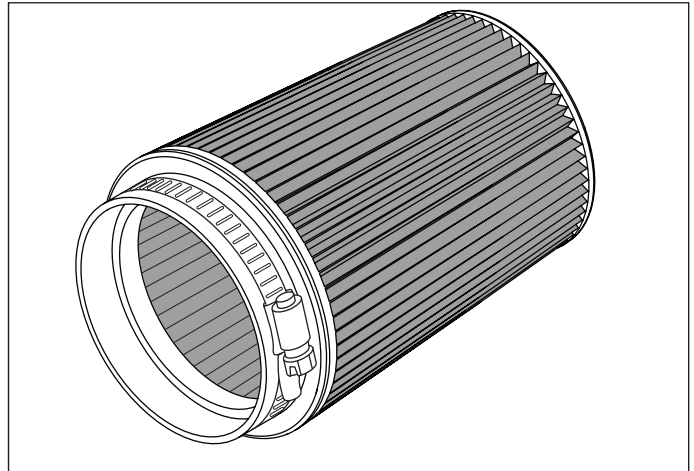

3. After inspection and/or cleaning, replace the air filter and snugly tighten the band clamp.

14.2.2 Cleaning Procedure

1. Liberally spray K&N Air Filter Cleaner and Degreaser (99-0606) onto both sides of filter and allow to soak for 10 minutes to loosen the dirt. Do not allow cleaner to dry on air filter.

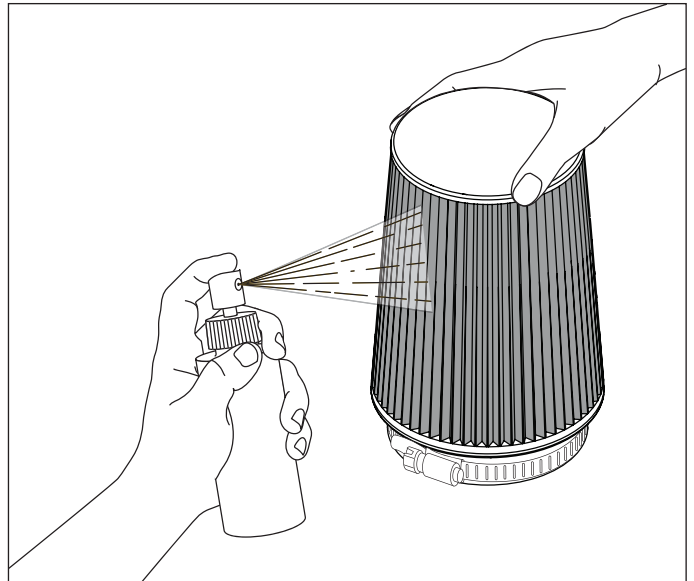

NOTICE

K&N Air Filter Cleaner is the only cleaner formulated to safely clean K&N air filters with cotton media. The use of any other cleaning solution could damage the cotton material.

2. Rinse the air filter with cool low-pressure water applied from the outside inward in order to flush the dirt out of the filter. Continue to rinse the filter until all traces of cleaner are gone. It may be necessary to repeat Steps 1 and 2.

3. After rinsing, gently shake off the excess water and air dry the filter.

NOTICE

Do not use compressed air to dry the filter. Do not apply oil to the filter until it is completely dry.

4. Spray K&N Aerosol Air Filter Oil (99-0504) evenly along the crown of each pleat holding nozzle about 3" away. Allow oil to wick for approximately 20 minutes. Touch up any light areas on either side of the filter until there is a uniform red color at all areas.

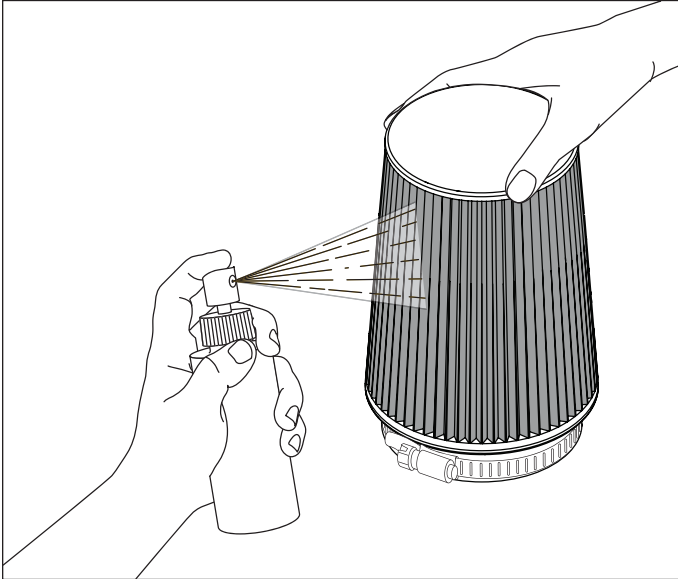

15. Wiring Diagrams and Troubleshooting

15.1 Operational Flow Chart

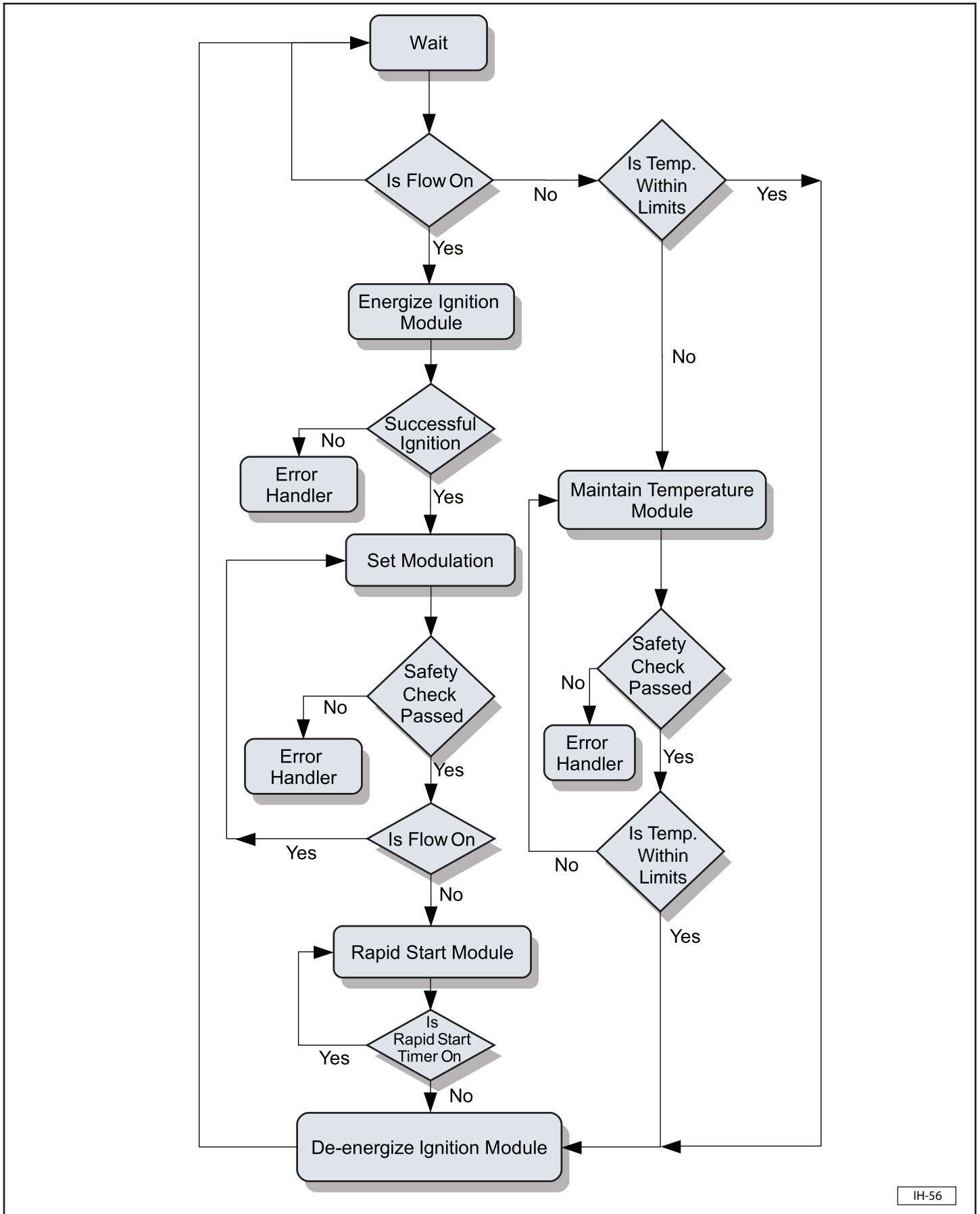

IH-56

15.2 Complete Wiring Diagram (all models)

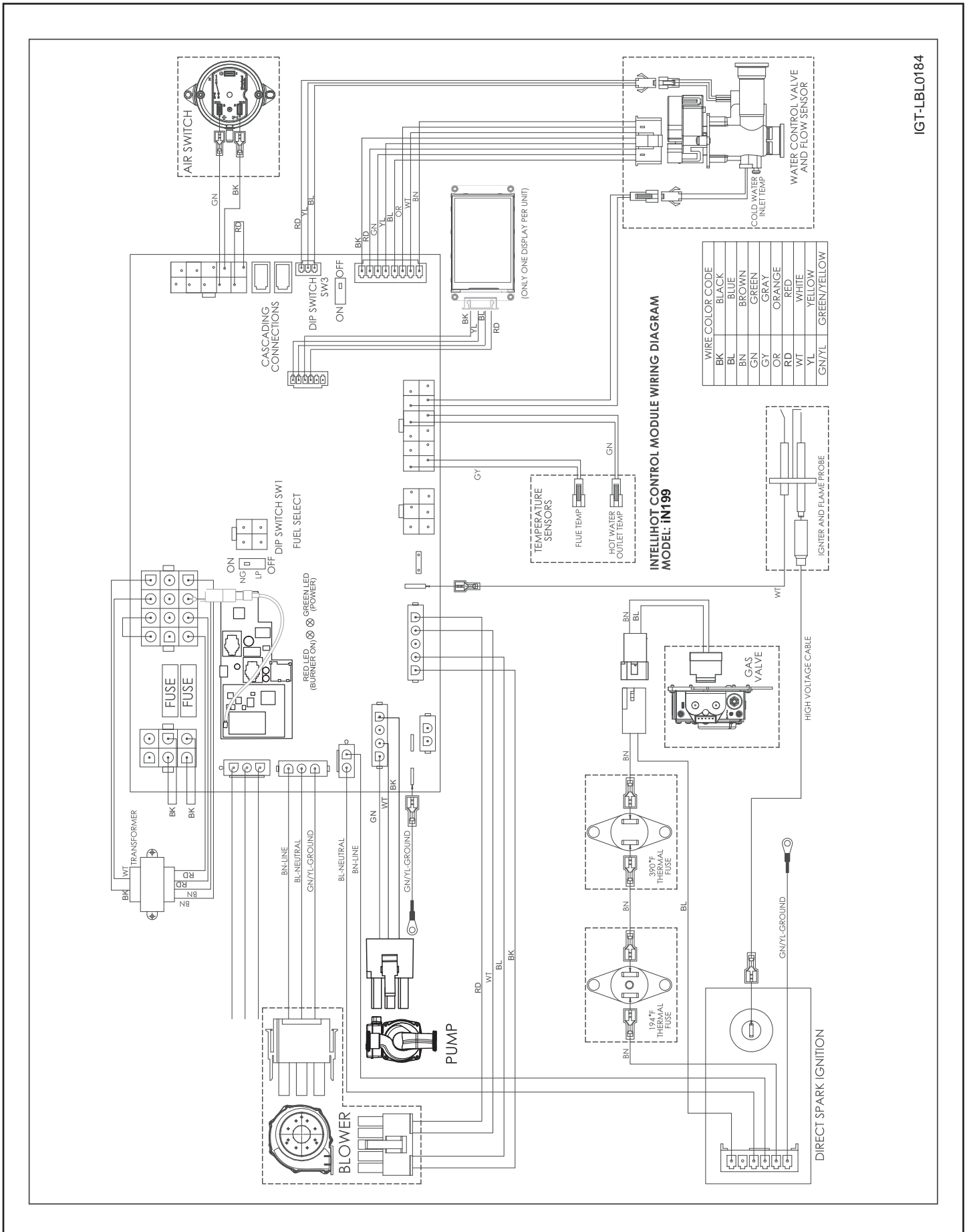



IGT-LBL0184



15.3 Troubleshooting Guide

Description	Possible Cause	Remedy
<p>Blower</p> <p>Blower Fault</p>  	<ul style="list-style-type: none"> Blower noisy / impeller jammed. Disconnected signal wire. Wiring faulty. 	<ul style="list-style-type: none"> Inspect blower / impeller. Clean and remove any obstructions. Check PWN signal. Check for loose wires, pins, and repair. If the problem persists, turn control panel OFF, shut gas valve, disconnect power from unit, and contact an authorized service technician.
<p>Igniter</p> <p>Ignition Fault</p>     	<ul style="list-style-type: none"> Water over-heat switch tripped. Faulty DSI, faulty igniter wire, faulty ignition connection, faulty PCB, bad igniter. Low gas pressure. Wiring faulty. 	<ul style="list-style-type: none"> Check pump, check cross-over solenoid. Electrical noise (DSI). Replace part. Adjust gas pressure at regulator, check / increase size of gas line, check for gas line blockage. If the problem persists, turn control panel OFF, shut gas valve, disconnect power from unit, and contact an authorized service technician.
<p>Open Sensors</p> <p>Inlet / Outlet Sensors</p>  	<ul style="list-style-type: none"> Unplugged connectors. Faulty sensor wiring. Faulty sensor. Heat engine water outlet temperature sensor. Flue temperature sensor. Inlet water temperature sensor. Faulty controller. 	<ul style="list-style-type: none"> Check connectors and ensure they are securely connected. Check for nicked or broken sensor wiring or connectors. Also check for corroded or wet connectors. Measure resistance of sensor at connector (18 kΩ at 50°F, 10 kΩ at 77°F, 3 kΩ at 140°F). Replace controller.

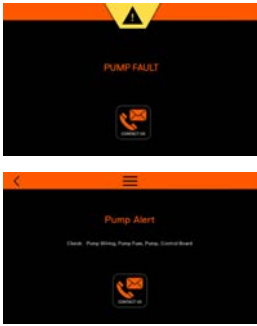
Description	Possible Cause	Remedy
<p>Faulty Sensors</p> <p>Inlet / Outlet Sensors</p> 	<ul style="list-style-type: none"> • Faulty sensor wiring or faulty sensor. • Inlet water temperature sensor. • Heat engine water outlet temperature sensor. • Faulty controller. 	<ul style="list-style-type: none"> • Check for nicked or broken sensor wiring or connectors. Also check for corroded or wet connectors. • Measure resistance of sensor at connector (18 kΩ at 50°F, 10 kΩ at 77°F, 3 kΩ at 140°F). • Replace controller.
<p>Heat Exchanger</p> <p>Outlet temperature exceeded set limit</p> 	<ul style="list-style-type: none"> • Flow rate changes excessive. • Faulty sensor wiring. • Faulty sensor. • Faulty controller. 	<ul style="list-style-type: none"> • Ensure the water flow rate does not change faster than 2 GPM every 5 seconds. • Check for nicked or broken sensor wiring or connectors. Also check for corroded or wet connectors. • Measure resistance of sensor at connector (18 kΩ at 50°F, 10 kΩ at 77°F, 3 kΩ at 140°F). • Replace controller.
<p>Flue</p> <p>Temperature Exceeded Set Limit</p> 	<ul style="list-style-type: none"> • Incorrect vent set up. • High inlet temperature. • Faulty sensor wiring. • Faulty sensor. • Faulty controller. 	<ul style="list-style-type: none"> • If vent pipe material is CPVC or polypropylene, ensure that CPVC is selected in the vent material screen. • Ensure inlet temperature is lower than 150°F if vent pipe material is PVC or lower than 190°F if vent pipe material is CPVC or polypropylene. • Check for nicked or broken sensor wiring and connectors. Also check for corroded or wet connectors. • Measure resistance of sensor at connector (18 kΩ at 50°F, 10 kΩ at 77°F, 3 kΩ at 140°F). • Replace controller.
<p>Blocked Flue Fault</p> 	<ul style="list-style-type: none"> • Exhaust blocked (bird, etc). • Backed up condensate. • Wiring loose (switch open). 	<ul style="list-style-type: none"> • Check exhaust termination. Check exhaust connection at water heater. Install screens to prevent blockage. • Check slope of drain. Check for double loops, air locks, or debris in loop. • Check wiring.

Description	Possible Cause	Remedy
<p>Flue sensor</p> 	<ul style="list-style-type: none"> • Unplugged connectors. • Faulty sensor wiring. • Faulty sensor. • Flue temperature sensor. • Inlet water temperature sensor. • Faulty controller. 	<ul style="list-style-type: none"> • Check connectors and ensure they are securely connected. • Check for nicked or broken sensor wiring or connectors. Also check for corroded or wet connectors. • Measure resistance of sensor at connector (18 kΩ at 50°F, 10 kΩ at 77°F, 3 kΩ at 140°F). • Replace controller.
<p>Cascading Alert</p> 	<ul style="list-style-type: none"> • Loss of communication among units. 	<ul style="list-style-type: none"> • Check for broken or nicked communication cable or loose connector. • Ensure that the communication cable is not bundled or tied to any high voltage lines. • Ensure dip switch (SW3) is ON in first and last units and OFF in all other units. • Ensure each unit numbering is unique.
<p>Water Valve</p> 	<ul style="list-style-type: none"> • Faulty sensor wiring. • Water valve clogged or damaged. 	<ul style="list-style-type: none"> • Check for nicked or broken sensor wiring or connectors. Also check for corroded or wet connectors. • Replace water valve.

Description	Possible Cause	Remedy
<p>Pump</p> 	<ul style="list-style-type: none"> • Faulty pump wiring. • Pump fuse blown. • Faulty pump. • Faulty controller. 	<ul style="list-style-type: none"> • Check for nicked or broken sensor wiring or connectors. Also check for corroded or wet connectors. • Replace fuse (5 Amp). • Replace pump. • Replace controller.
<p>Fuel Type</p> 	<ul style="list-style-type: none"> • Wrong fuel type being used. 	<ul style="list-style-type: none"> • Use correct fuel type.
<p>Software</p> 	<ul style="list-style-type: none"> • Incorrect settings. • Incompatible settings. • Incorrect software version. • Faulty wiring. 	<ul style="list-style-type: none"> • Review and correct settings. • Review and correct settings. • Update software version. • Check for nicked or broken sensor wiring or connectors. Also check for corroded or wet connectors.

Description	Possible Cause	Remedy
<p>Manifold Sensors</p> 	<ul style="list-style-type: none"> • Unplugged connectors. • Faulty sensor wiring. • Faulty sensor. • Flue temperature sensor. • Inlet water temperature sensor. • Faulty controller. 	<ul style="list-style-type: none"> • Check connectors and ensure they are securely connected • Check for nicked or broken sensor wiring or connectors. Also check for corroded or wet connectors • Measure resistance of sensor at connector (18 kΩ at 50°F, 10 kΩ at 77°F, 3 kΩ at 140°F) • Replace controller.
<p>System Alert / Fault</p> 	<ul style="list-style-type: none"> • A system alert or fault is present (main menu screen). • Malfunction of monitored part or system. 	<ul style="list-style-type: none"> • Press the Menu bar and refer to the remedy for indicated part or system.
<p>Alive</p> 	<ul style="list-style-type: none"> • Shows status of water heater. • Sleep mode. • Sleep mode passcode protected. • Indicates a fault exists within the monitored parts or system. 	<ul style="list-style-type: none"> • Touch display screen to awake. • Refer to the remedy for indicated part or system. • Refer to the remedy for indicated part or system.

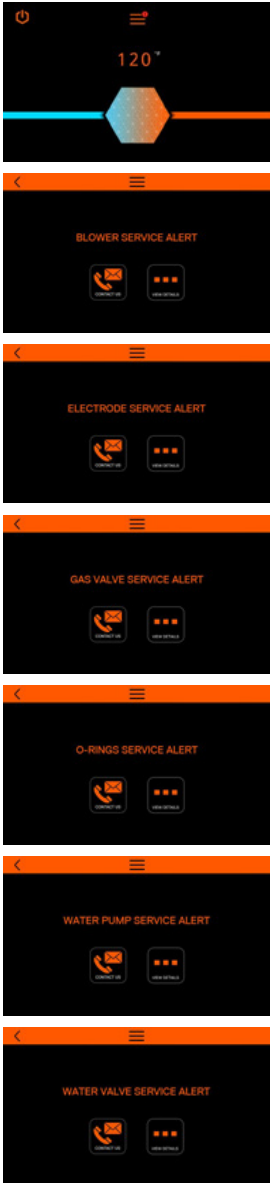
Description	Possible Cause	Remedy
<p>Service Alert</p> 	<ul style="list-style-type: none"> • A system alert or fault is present (main menu screen). • Malfunction of monitored part or system. 	<ul style="list-style-type: none"> • Press the Menu bar and refer to the remedy for indicated part or system.

16. Serviceable Parts

16.1 Display

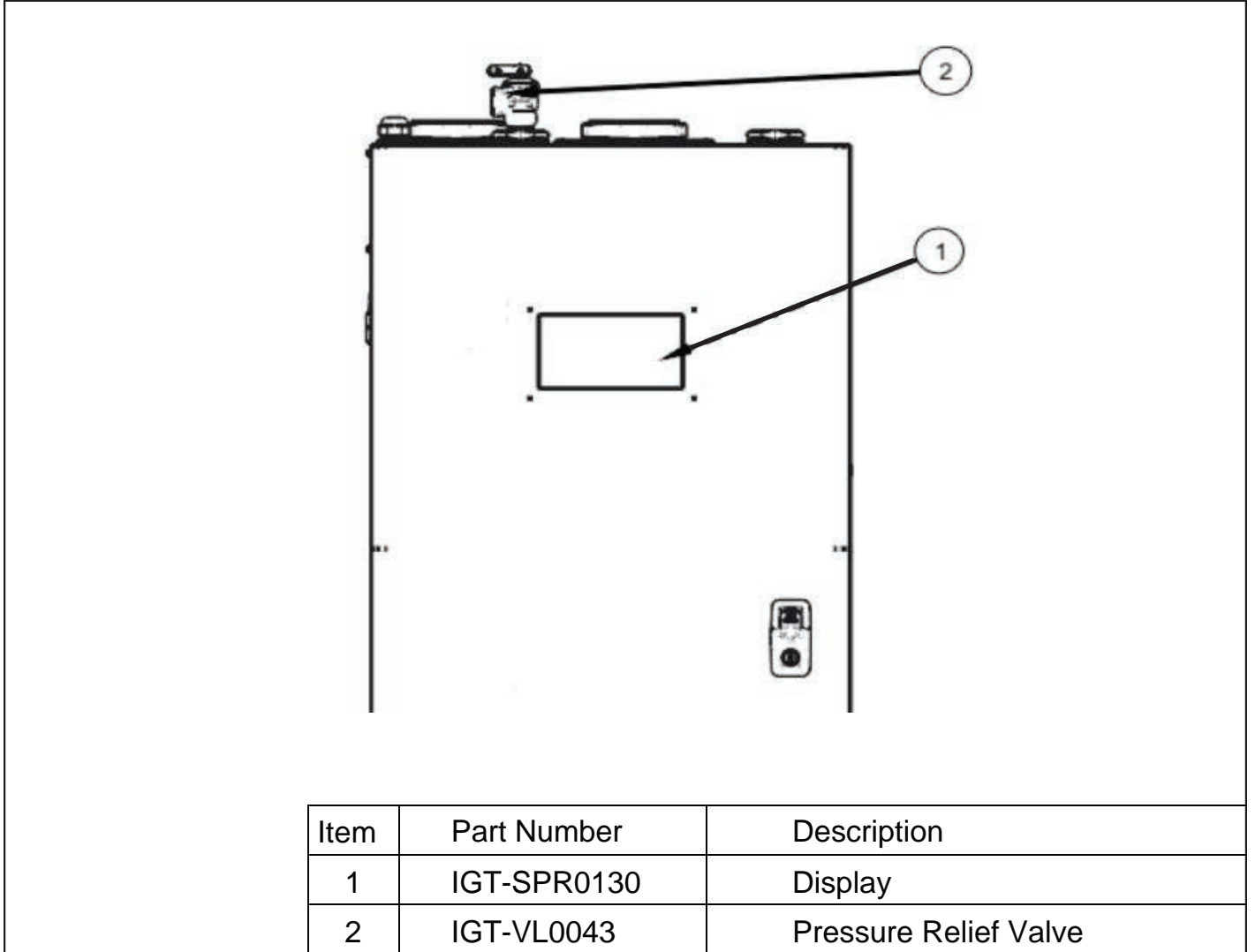

16.2 Control Board

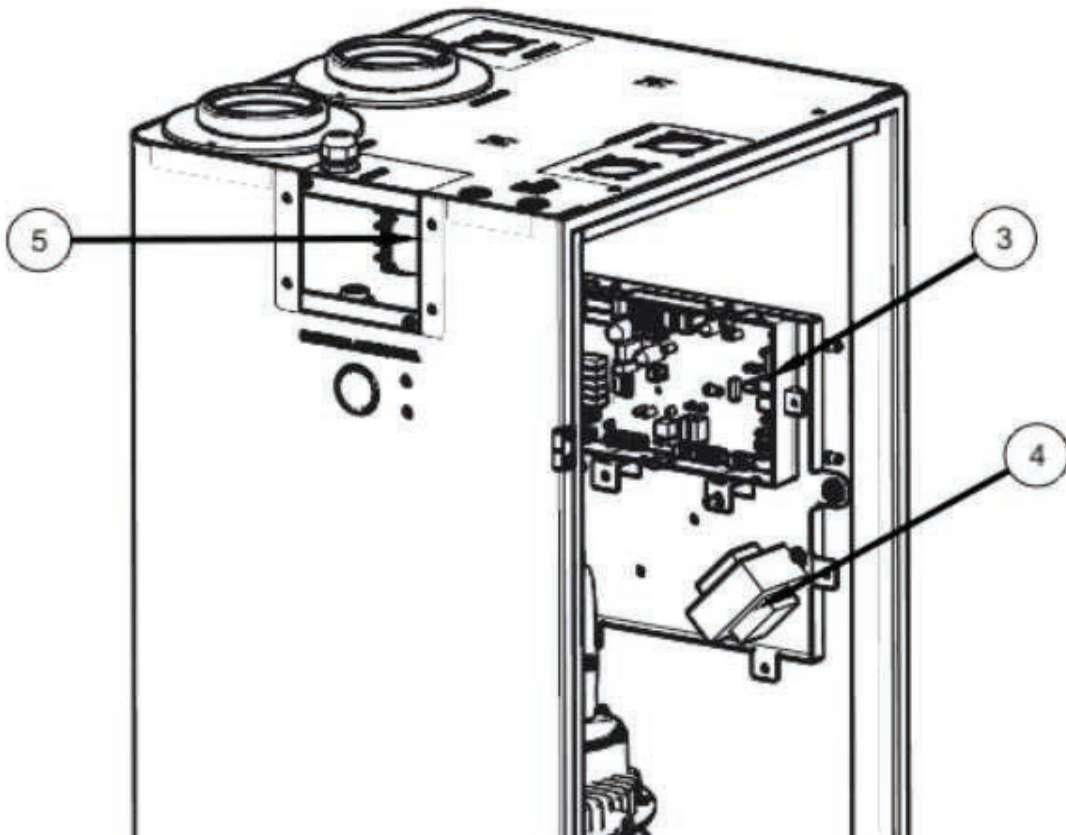

Item	Part Number	Description
3	IGT-SPR0129	Control Board
4	IGT-SPR0065	Transformer Kit
5	IGT-ELC0138	Rocker Switch

16.3 Water Circuit (top side)

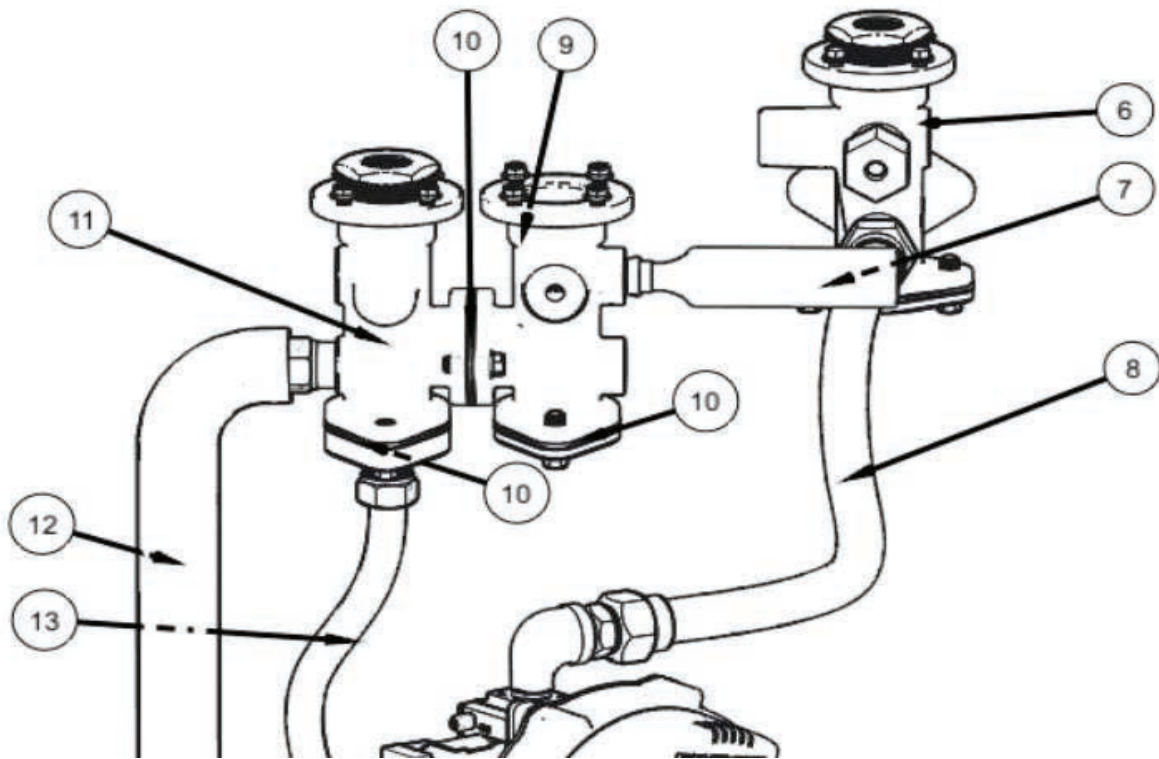

Item	Part Number	Description
6	IGT-FTT0235-5	Gas Out Casting
7	IGT-PLG0018	Water Hammer Arrestor
8	IGT-PLG0014	Gas Tube
9	IGT-FTT0235-3	Hot Side Water Out Casting
10	IGT-SLS0041	Seal
11	IGT-FTT0235-1	Cold Side Water Out Casting
12	IGT-LNE0064	Corrugated Line
13	IGT-LNE0061	Corrugated Line

16.4 Water Circuit (bottom side)

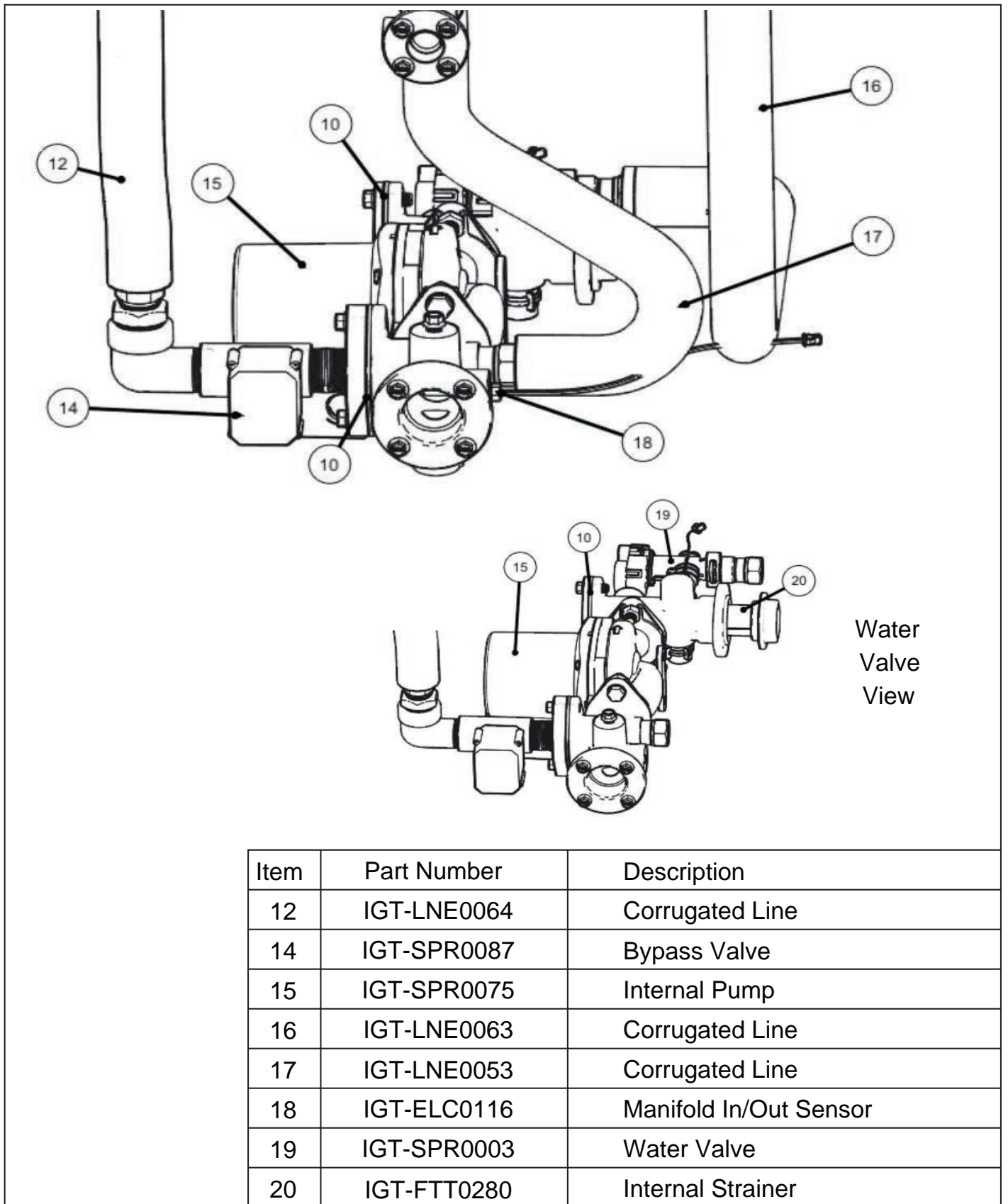

16.5 Exhaust

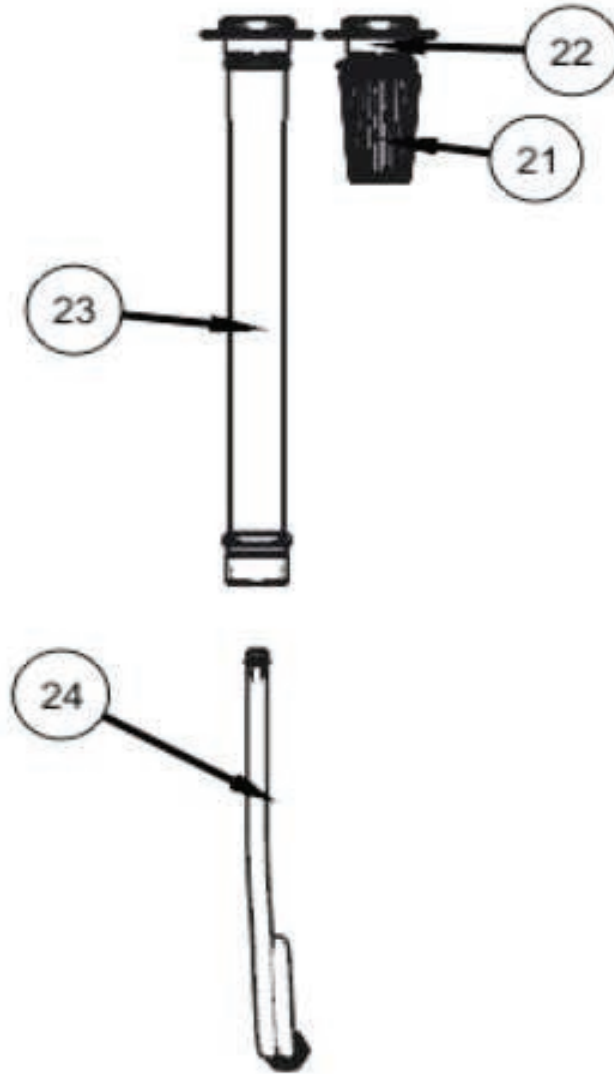

Item	Part Number	Description
21	IGT-FLTR0009	Air Filter
22	IGT-EX0035	Air Intake
23	IGT-EX0034	Exhaust
24	IGT-TB0015	Condensate Hose

16.6 Heat Exchanger

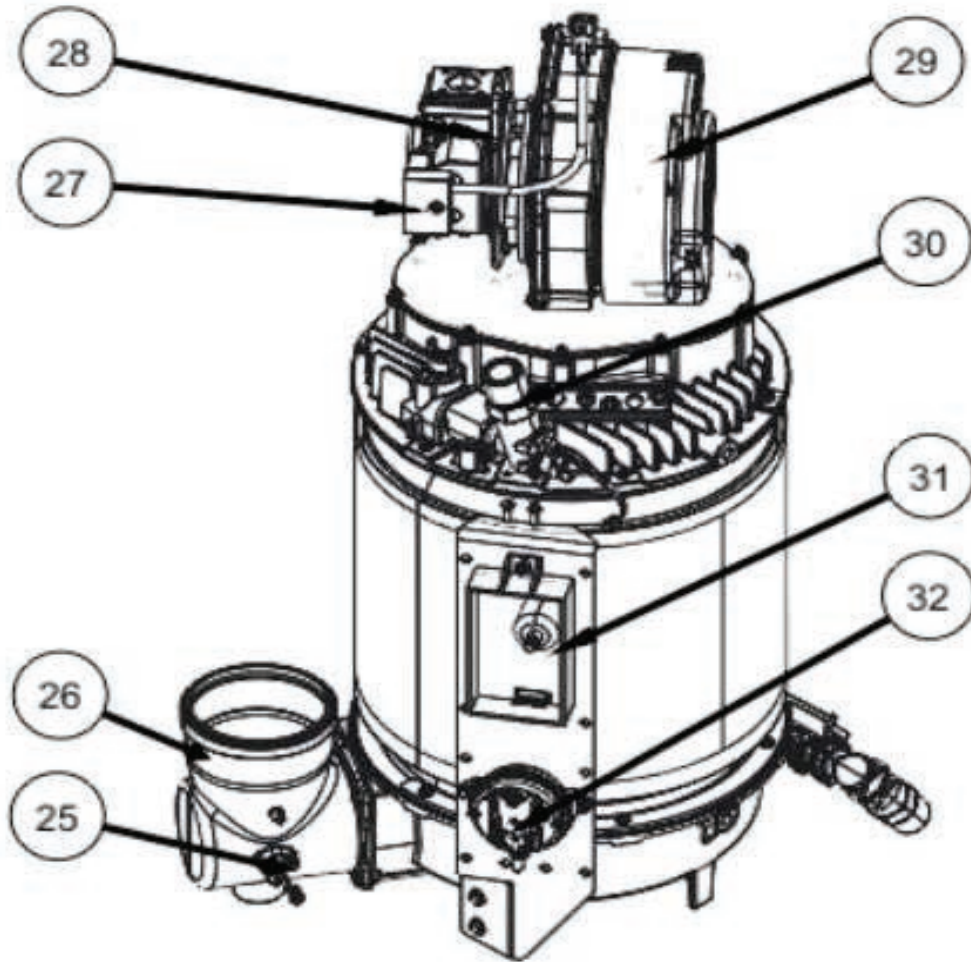

Item	Part Number	Description
25	IGT-ELC0062	Flue Sensor
26	IGT-CST002	Side Cast
27	IGT-ELC0020	Gas Valve Harness
28	IGT-SPR0011	Gas Valve Harness
29	IGT-SPR0127	Blower Kit
30	IGT-SPR0012	Outlet Assembly
31	IGT-SPR0005	DSI
32	IGT-ELC0007	Internal Strainer

16.7 Heat Exchanger (top side)

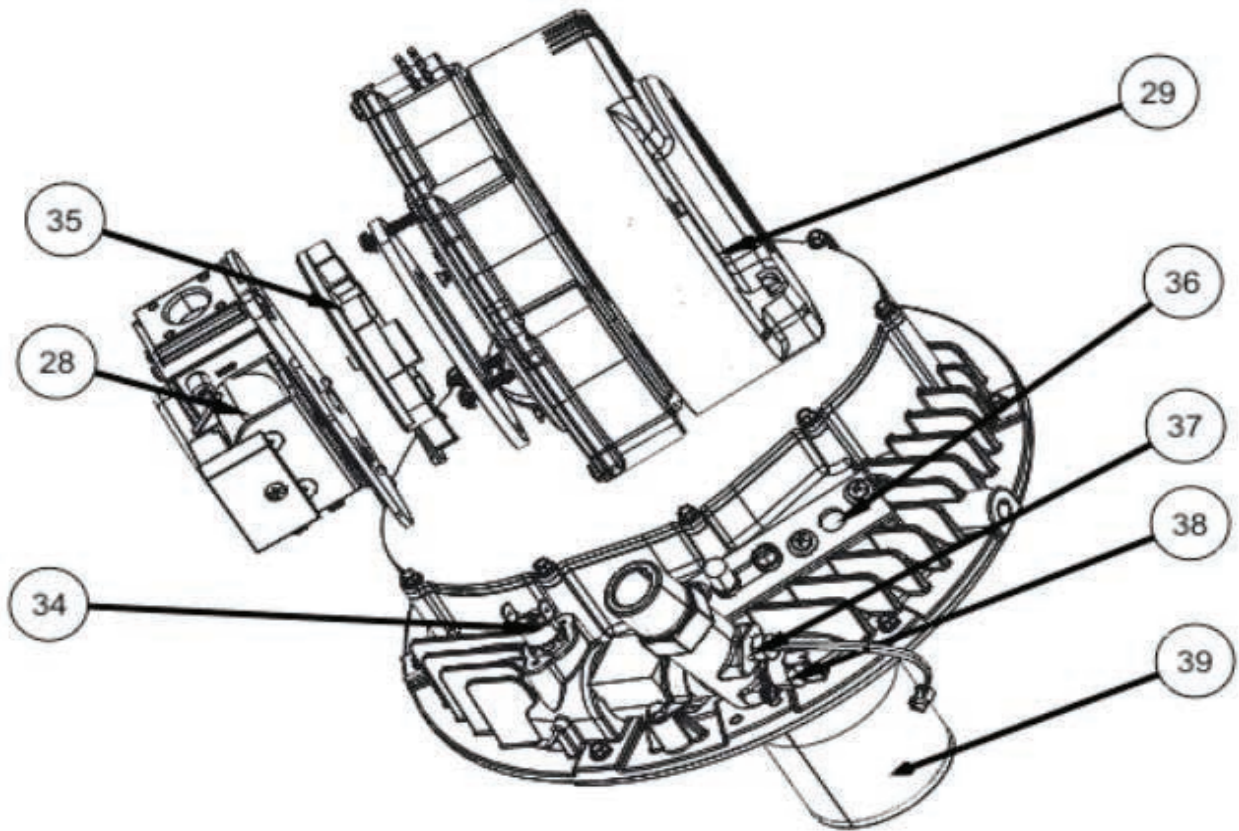

Item	Part Number	Description
28	IGT-SPR0011	Gas Valve Kit
29	IGT-SPR0127	Blower Kit
34	IGT-SPR0097	Non-Resettable Switch
35	IGT-ELC0147	Gray Swirl Plate
36	IGT-SPR0106	Electrode Kit
37	IGT-ELC0081	Outlet Sensor
38	IGT-SPC0066	Resettable Switch
39	IGT-SPC0111	Burner Kit

16.8 Miscellaneous

Part Number	Description
IGT-ELC0092	25 ft cascading cable
IGT-ELC0232	50 ft cascading cable
IGT-SPR0110	Gen II V 2 Sensors Kit (includes manifold inlet, manifold outlet, flue, and hotwater outlet sensors)
IGT-SPR0109	Gen II V 2 O-Ring kit
IGT-ELC0181	DSI to Electrode HV Cable
IGT-ELC0131	Heat Exchanger to Control Board Harness
IGT-ELC0319	Gas Pressure Sensor
IGT-ELC0320	Water Pressure Sensor
IGT-ELC0349	Water and Gas Pressure Sensors Harness
IGT-ELC0352	Pump to Control Board Harness
IGT-ELC0353	Power Harness, Control Board to Rocker Switch
IGT-ELC0354	Manifold Inlet Wiring Harness
IGT-ELC0355	Manifold Outlet Wiring Harness
IGT-ELC0356	Bypass Valve Wiring Harness
IGT-ELC0319	Gas Pressure Sensor
IGT-ELC0320	Water Pressure Sensor
IGT-ELC0288	Display Wiring Harness
IGT-CST0031	Flapper

17. Requirements for State of Massachusetts

17.1 Notice Before Installation

This appliance must be installed by a licensed plumber or gas fitter in accordance with the Massachusetts Plumbing and Fuel Gas Code 248 CMR Sections 2.00 and 5.00.

IMPORTANT: In the State of Massachusetts (248 CMR 4.00 & 5.00)

For all side wall horizontally vented gas fueled equipment installed in every dwelling, building or structure used in whole or in part for residential purposes, including those owned or operated by the Commonwealth and where the side wall exhaust vent termination is less than seven (7) feet above finished grade in the area of the venting, including but not limited to decks and porches, the following requirements shall be satisfied:

1. INSTALLATION OF CARBON MONOXIDE DETECTORS.

At the time of installation of the side wall horizontal vented gas fueled equipment, the installing plumber or gasfitter shall observe that a hard wired carbon monoxide detector with an alarm and battery backup is installed on the floor level where the gas equipment is to be installed. In addition, the installing plumber or gasfitter shall observe that a battery operated or hard wired carbon monoxide detector with an alarm is installed on each additional level of the dwelling, building, or structure served by the side wall horizontal vented gas fueled equipment. It shall be the responsibility of the property owner to secure the services of qualified licensed professionals for the installation of hard wired carbon monoxide detectors.

- a. If the side wall horizontally vented gas fueled equipment is installed in a crawl space or an attic, the hard wired carbon monoxide detector with alarm and battery back-up can be installed on the next adjacent floor level.
- b. If the requirements of this subdivision cannot be met at the time of completion of installation, the owner shall have a period of thirty (30) days to comply with the above requirements; provided, however, that during said thirty (30) day period, a battery operated carbon monoxide detector with an alarm shall be installed.

2. APPROVED CARBON MONOXIDE DETECTORS.

Each carbon monoxide detector, as required in accordance with the above provisions, shall comply with NFPA 720 and be ANSI/UL 2034 listed and IAS certified.

3. SIGNAGE.

A metal or plastic identification plate shall be permanently mounted to the exterior of the building at a minimum height of eight (8) feet above grade directly in line with the exhaust vent terminal for the horizontally vented gas fueled heating appliance or equipment. The sign shall read, in print size no less than one-half (1/2) inch in size, "GAS VENT DIRECTLY BELOW. KEEP CLEAR OF ALL OBSTRUCTIONS".

4. INSPECTION.

The state or local gas inspector of the side wall horizontally vented gas fueled equipment shall not approve the installation unless, upon inspection, the inspector observes carbon monoxide detectors and signage installed in accordance with the provisions of 248 CMR 5.08(2)(a)1 through 4.

18. Warranty

18.1 Warranty

General

This unit is warranted by Intellihot Inc., and covers defects in materials and workmanship, subject to the applicable time periods and terms below. The warranty effective start date begins on the date of commissioning.

This warranty is extended to the original purchaser and any subsequent owner at the original installation location, and applies only when properly installed by a licensed contractor and operated in accordance with the instruction manuals. This warranty is limited to repairs or replacement of parts, at Intellihot's option, that are proven to be defective under normal use and connected only to potable water systems.

Warranty Period

Commercial Domestic Hot Water (DHW) Warranty: Heat Engine coil - 6 years, Other Parts - 1 years.

Heat Engine Coil

The warranty period for a heat engine coil failure, when installed in a Commercial DHW application is six (6) years from the effective start date.

All Other Parts and Components

The warranty period for any original parts (excluding the heat engine coil) against failure, is one (1) years from the effective start date. A replacement part is warranted for the unexpired term of the original warranty. Defective parts submitted can not be returned. No returns will be accepted without prior authorization from Intellihot.

Definition of Potable water

Potable water is defined as drinkable water supplied from utility or well water in compliance with EPA secondary maximum contaminant levels (40 CFR part 143.3) as shown in the table.

Contaminant	Level
Aluminum	0.05 to 0.2 mg/l
Chloride	250 mg/l
Color	15 color units
Copper	1.0 mg/l
Corrosivity	Non-corrosive
Fluoride	2.0 mg/l
Foaming Agents	0.5 mg/l
Iron	0.3 mg/l
Manganese	0.05 mg/l
Odor	3 threshold odor number
pH	6.5-8.5 mg/l
Silver	0.1 mg/l
Sulfate	250 mg/l
Total dissolved solids (TDS)	500 mg/l
Zinc	5 mg/l

Shipping Costs

If a replacement part is supplied under the terms of this warranty, Intellihot provides ground service delivery for the part free of charge. Any expedited shipping expense is paid by the customer.

Water Hardness Criteria

This warranty applies only when the water quality and supply meet the parameters outlined in the table below.

To use the table, locate the desired unit setpoint temperature on the left side of the table. Then locate the incoming water pressure across the top. The corresponding value in the table is the maximum allowable hardness in grains per gallon (gpg).

Maximum Allowable Hardness (grains per gallon, gpg)						
Unit Setpoint (°F)	Incoming Water Pressure (psi)					
	30	40	50	60	80	100
100-119	8	15	20	25	30	30
120-139°	5	11	15	20	27	30
140-159°	4	5	11	13	18	20
160-190°	3	4	10	12	15	17

Not Covered by this Warranty

This warranty does not cover failures or problems due to:

- Failure to install in accordance with applicable building codes, ordinances, normal plumbing, or electrical trade practices.
- Improper installation, improper use, improper maintenance, improperly made replacements or repairs, accidents or abuse.
- Sediment deposits, fire, flood, lightning, freezing, and acts of God, or any causes other than defects in materials and workmanship.
- The unit is installed without consideration for an adequate drain to accommodate leaks,
- The unit installed where the leakage could result in damage to the area adjacent to the water heater or to the lower floors of the building.
- Damages due to improper/inadequate water hardness treatment or damages from scale formation due to water hardness.
- Water heater's usage flow rate required a water hammer arrestor, but water hammer arrestor not installed.
- Electrical failures due to inadequately sized electrical breaker or inadequately sized wire
- Not performing recommended maintenance.
- Not properly electrically grounding the unit or not following the electrical grounding requirements.

This warranty will be void and have no effect if:

- The unit is modified or altered in any way.
- Appliance(s) or equipment are attached to the unit that have not been approved by Intellihot Inc.
- If the unit is used exclusively as a booster heater for a commercial dishwasher, or if the water from a reverse osmosis or deionized process is run directly through the unit.
- The serial number is altered, defaced, or discarded.

Warranty Limitations

This warranty applies only when the unit is used in the United States or Canada. Except for the limited warranties provided above, Intellihot Inc. disclaims any and all other warranties, including but not limited to warranties of merchantability and fitness for a particular purpose; provided however, that implied warranties of merchantability and fitness for a particular purpose are not disclaimed during the 1-year period from the date of commissioning. Intellihot shall not be liable for indirect, special, incidental, consequential, or other similar damages, including lost profits, arising from or relating to the unit. This warranty gives you specific legal rights, and you may also have other rights which vary from state to state.

How to Make a Claim

The warranty claim can be submitted online at <https://www.intellihot.com/warranty-claim/>

or

by calling (877) 835-1705. Proof of purchase in the form of a dated sales receipt or warranty registration should be included with your claim. The product owner should submit the warranty claim directly to Intellihot at the following address:

Intellihot Inc.
Attn: Warranty Claims
2900 W. Main St.
Galesburg, IL 61401

All parts claimed to be defective may be requested to be returned to Intellihot for examination prior to full claim settlement. Please include the following information on your warranty claim:

- Model number and serial number of the unit.
- Date of original purchase.
- Owner's name and address.
- A description of the problem with the part and unit.

How to Make a Claim

Call (877) 835-1705. Proof of purchase in the form of a dated sales receipt or warranty registration should be included with your claim. The product owner should submit the warranty claim directly to Intellihot at the following address:

Intellihot Inc.
Attn: Warranty Claims
2900 W. Main St.
Galesburg, IL 61401

All parts claimed to be defective can be requested to be returned to Intellihot for examination prior to full claim settlement.

Please include the following information on your warranty claim:

- Model number and serial number of the unit.
- Date of original purchase.
- Owner's name and address.
- A description of the problem with the part and unit.

19. Product Warranty Registration

19.1 Warranty

To register via the telliCare app, refer to “12.9.3 telliCare Service (Subscribe at Startup)” on page 44.

Or fill out the information in the form below and mail to the following address:

Warranty Registration
Intellihot Inc.
2900 W. Main Street
Galesburg, IL 61401

Make a copy or cut here to remove page.

Model: _____

Serial Numbers (up to 4):

Owner Information:

Name: _____

Address: _____

City, State, Postal Code: _____

Phone Number: _____

Dealer Information:

Sold By: _____

Address: _____

City, State, Postal Code: _____

Phone Number: _____

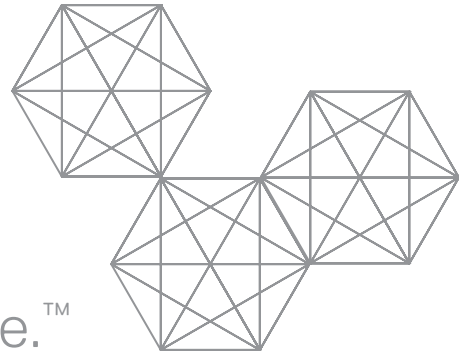

Endless water. Zero waste.™

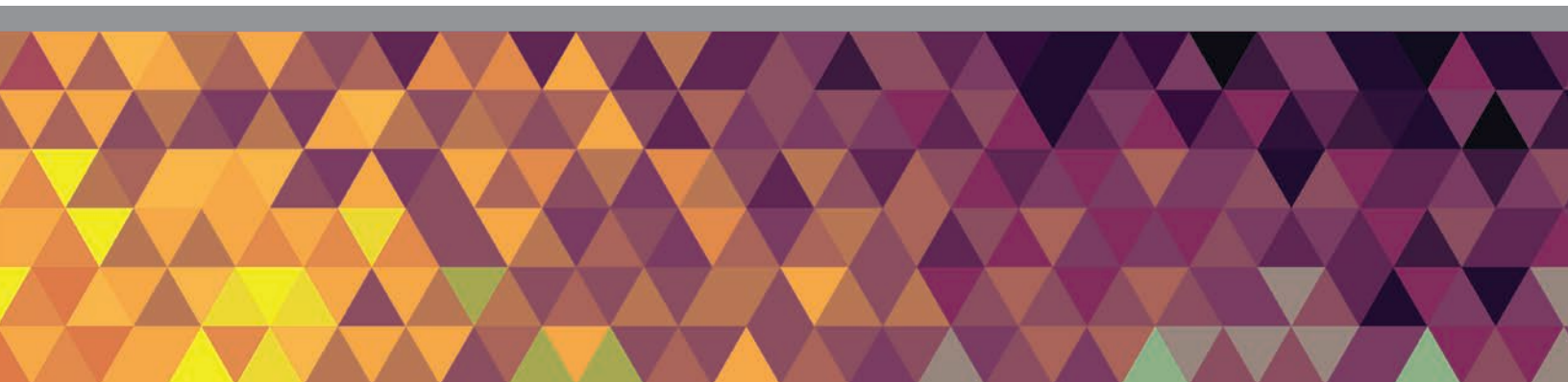

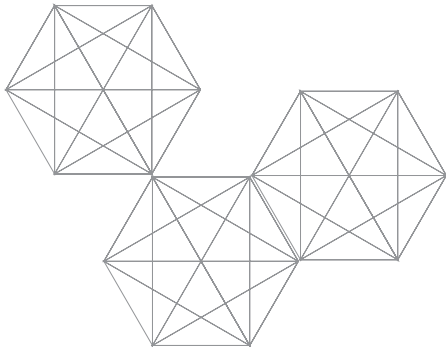

Intellihot

03-2023
Part#: IGT-MNL0060

